

Edition 03/2012

Prosthetic Procedure for TS & GS Implant System

PROSTHETIC PROCEDURE

for TS & GS Implant System

OSSTEM[®]
IMPLANT

OSSTEM Germany GmbH
Mergenthalerallee 25
D-65760 Eschborn
Tel: +49 (0) 61 96 / 777 55 - 0
www.osstem.com
www.sinuskit.com

Manufacturer
#507-8, Geoje3-dong, Yeonje-gu
Busan, Korea Zip: 611-804
Tel: +82 51 850 25 00
Fax: +82 51 861 46 93

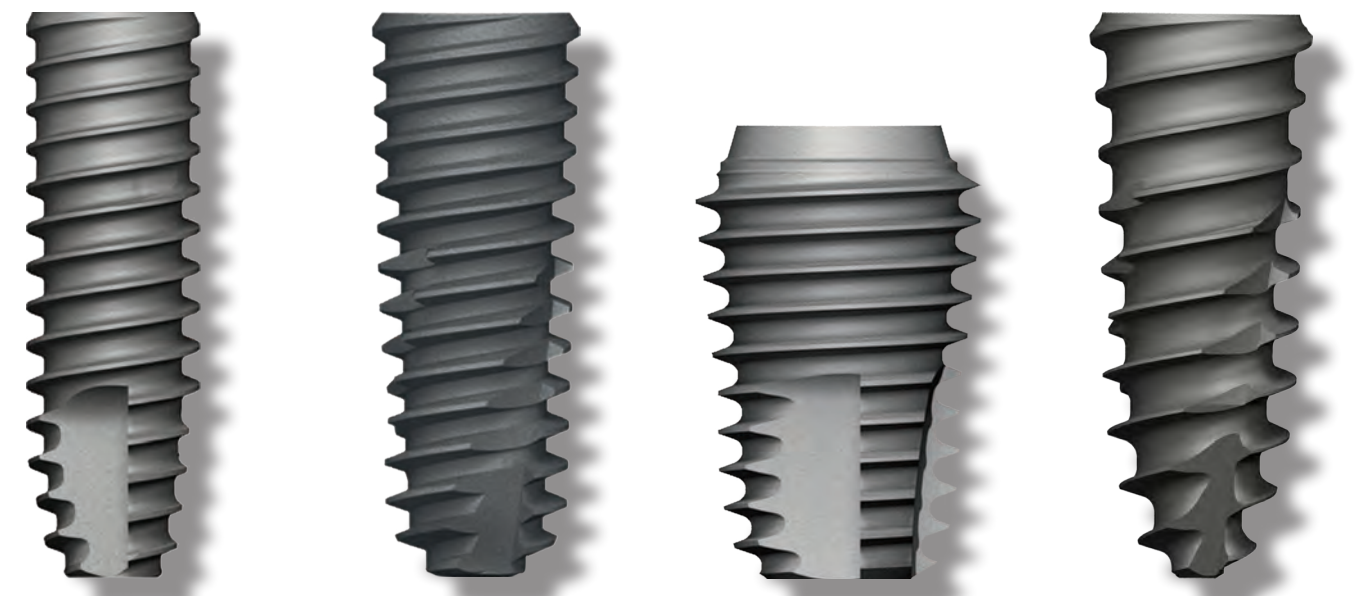

OSSTEM[®]
IMPLANT

OSSTEM[®]
IMPLANT

PROSTHETIC PROCEDURE

for TS & GS Implant System



TSII



TSIII



TSIII

Ultra Wide®

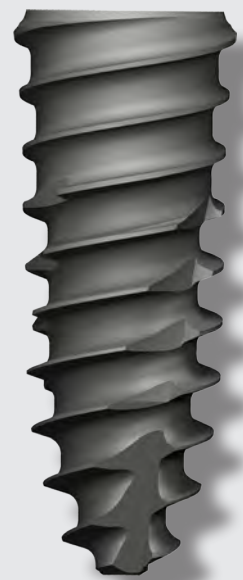

TSIV

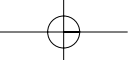

TS & GS Implant System

Contents

Cement retained restoration



When abutment reduction is unnecessary 09
 When abutment reduction is necessary 16

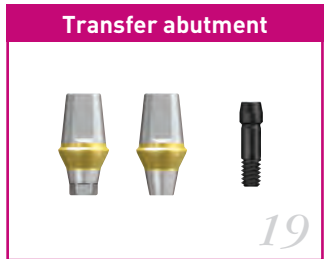

Fixture level Impression 23
 Abutment level Impression 30



Fixture level impression 35



Cement retained restoration 44
 Screw retained restoration 49



FreeForm ST abutment 57

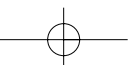

Screw retained restoration



Screw retained restoration 70

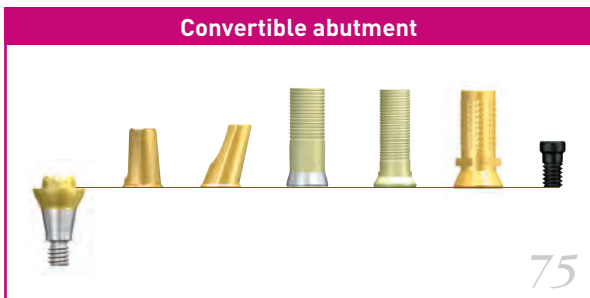

Combi type restoration 78

Screw retained restoration 85

Overdenture restoration

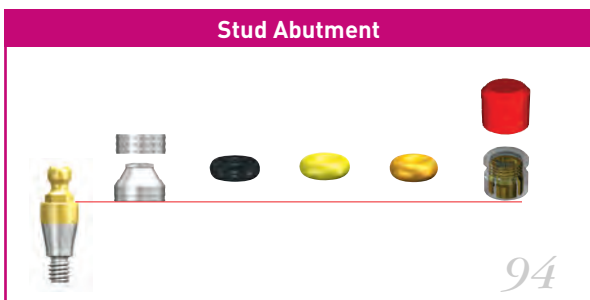

O-ring & Dalbo system 97

TS & GS Bite Index 105

TS & GS Fixture level Impression Coping 107

X-ray inspection method for TS & GS 109

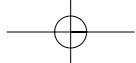

TS & GS Cover screw

Feature & benefit

- Coloring convenient for installation position verification at second surgery.
- Feature composition according to the installation depth of the fixture

Material

- Ti CP-Gr-3 • Coloring : anodizing • Tightening torque : Hand tightening (less than 10Ncm)

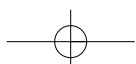
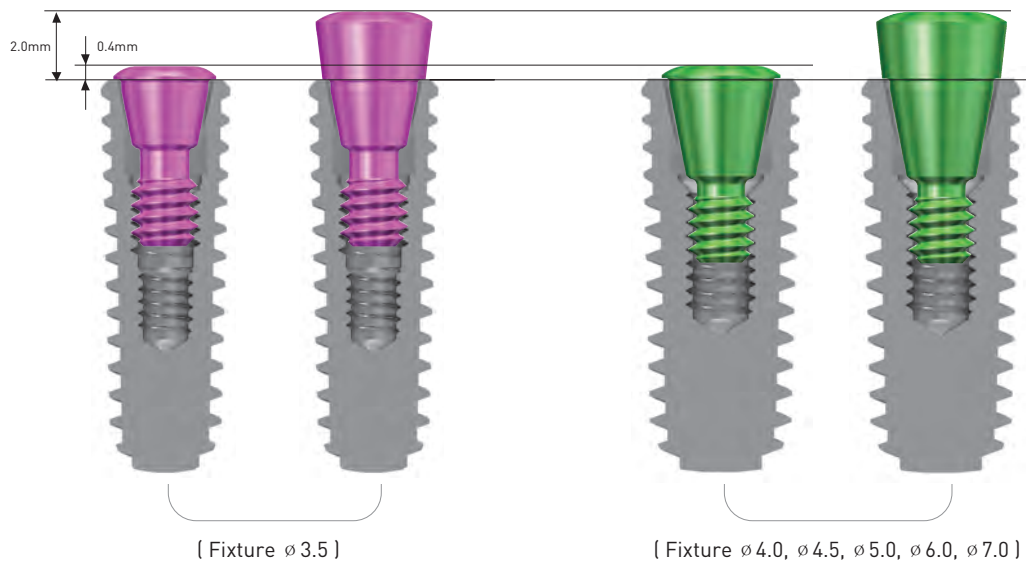

TS & GS Healing abutment

- Feature & benefit**
- Wide range of application and emergence profile that is advantageous for keeping a design.
- Selection method**
- After checking the inter-occlusal space between the opposing tooth select a height that leaves 1-2 mm exposure above the gingiva.
 - Select a diameter similar to the abutment that will be used.
- Material**
- Ti CP-Gr4 - Tightening torque : Hand tightening (less than 10Ncm)

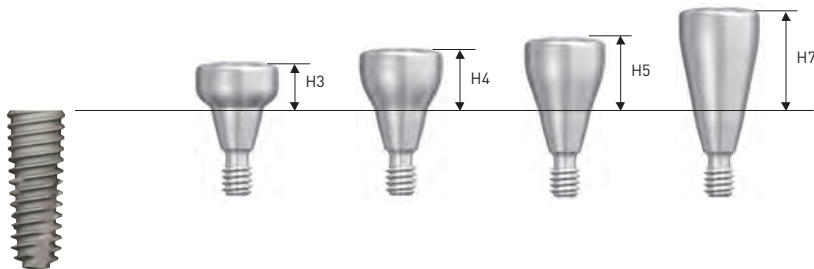

※ Matching Table for Healing ABT. & Abutment

Healing ABT. (H)	3	4	5	7
Abutment (G/H)	1	2 or 3	3 or 4	more than 5

TS & GS Rigid abutment

- **Indication**

- Single/bridge/full arch restorations
- All position
- Only cement retained restoration

- **Contraindication**

- Misalignment bridge case
- Over angulated case







- **Feature & benefit**

- Snap on impression at abutment level
- Abutment design reflecting the tooth position/restorative prosthesis
- Margin esthetic effect with gold coloring

- **Material** - Ti-6Al-4V
- **Surface** - TiN coating
- **Tightening torque** - 30 Ncm

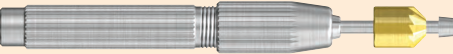
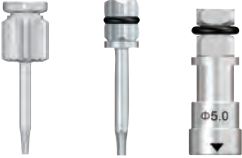

Product list for prosthetic procedure

Product list	
Abutment	
Protect cap	
Impression coping	
Lab analog	
Burn-out cylinder	
Finishing reamer	
Driver	
Torque wrench	

- Exclusive matching components for each rigid abutment of 4/5.5/7mm height.
Every component can be verified by color as 4mm-yellow, 5.5mm-grey, 7mm-blue.
Essential to check the color before using the impression coping/lab analog .
- Common use of 1.2 hex driver/outer driver with the exception of \varnothing 4.0 diameter.
Possible to gain an extra-stable connection by using a outer driver. (Use \varnothing 4.0-only outer driver)

Note for prosthetic process

Abutment diameter selection

- The Rigid abutment has 4/5.5/7mm height, and besides to the 1/2/3/4/5mm gingival height there are a variety of margin diameters as $\phi 4.0/\phi 4.5/\phi 5.0/\phi 6.0/\phi 7.0$ considering the prosthesis for each tooth position. It is possible to conveniently fabricate an esthetic prosthesis by referring to the recommendation table below.



Position	Rigid abutment diameter
	$\phi 4.5$
	$\phi 4.0$
	$\phi 5.0/\phi 6.0$

$\phi 7.0$ is used for GS Ultra Wide fixture

Mini/Regular abutment

- The $\phi 4.0/\phi 4.5$ feature has identical diameter but the applied fixture is differentiated into mini/regular. It is essential to verify the fixture that has been used and use a matching abutment.

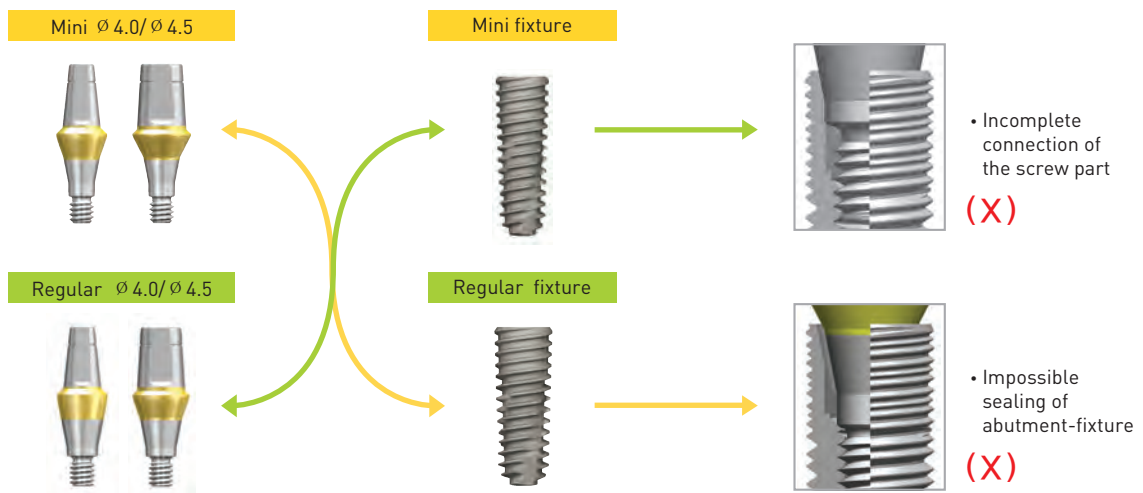



DENTAL CLINIC WORKING

When abutment reduction is unnecessary

Step1 Healing abutment separation

Components & tools

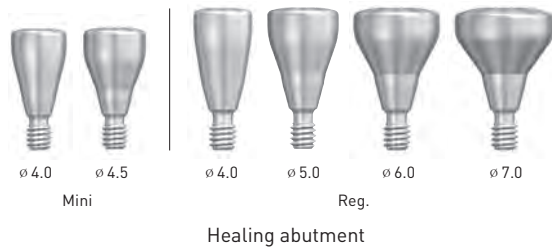

Prosthetic procedure

Separate the Healing abutment with hand force using a 1.2 hex hand driver.



Healing abutment verification



Gently separate the Healing abutment with hand force.



When abutment reduction is unnecessary

Step2 Abutment selection and connection

Rigid abutments & tools

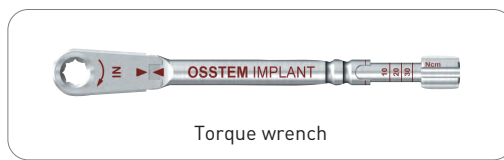

Prosthetic procedure

Select an appropriate abutment considering the prosthesis and oral environment of the patient and connect it using a 1.2 hex torque or outer driver. It used 30Ncm. Always verify the exactness of the connection by taking an x-ray after the final connection of the abutment.



Connect with a 1.2 Torque driver



Connect with a Outer driver



Attached Rigid abutment



Step3 Impression

Rigid impression copings

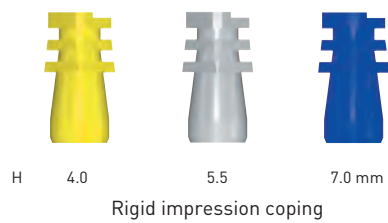
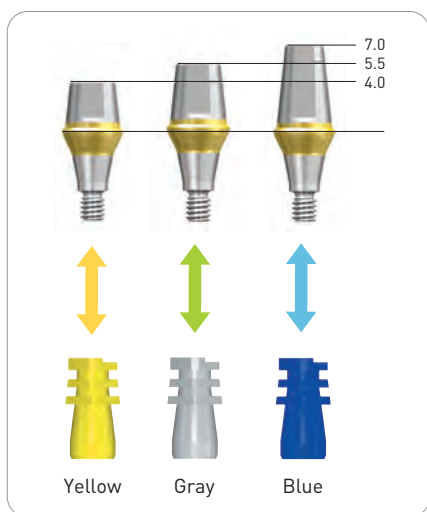

Prosthetic procedure

Select an impression coping of identical features with the abutment and press with your hand to connect. Do not forget to use an abutment height of 4/5.5/7 mm and exclusive impression coping. After connecting the coping, take an impression following the conventional method using a ready made tray.



Impression coping connection



Impression material injection



Impression taking completed



When abutment reduction is unnecessary

Step4 Protect cap connection and fabrication of the temporary prosthesis.

Rigid protect caps

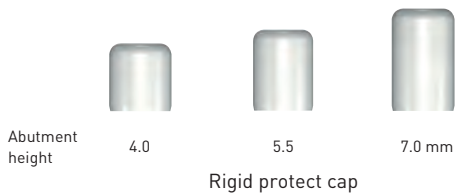

Prosthetic procedure

After taking the impression press the protect cap on until the prosthesis is completed. In cases when a temporary prosthesis is necessary it is convenient to customize the protect cap to make a temporary prosthesis.



Protect cap connection



Temporary prosthesis fabrication using a protect cap



DENTAL LAB WORKING

Step5 Working model fabrication

Rigid lab analogs

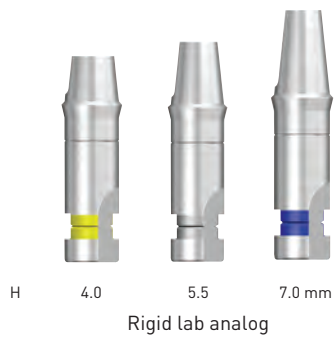
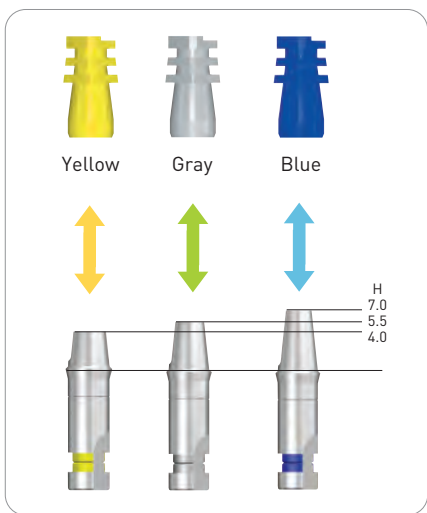

Prosthetic procedure

Check the color of the impression coping in the impression body and connect an exactly matching lab analog to its surface. Apply separator around the analog and replicate the gingival area with exclusive material. Use the border of the lab analog as a reference line. Pour dental stone following the conventional method to complete a working model.



Lab analog connection & gingival area replication



Completed working model



When abutment reduction is unnecessary

Step6 Burn-out cylinder connection wax-up & casting

Rigid burn-out cylinders & tools

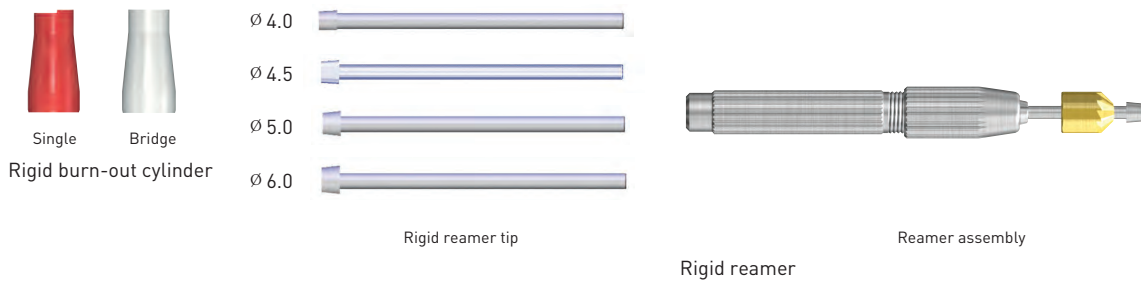

Prosthetic procedure

You can fabricate a prosthesis with precise fit using a burn-out cylinder. Press to connect the appropriate burnout cylinder for single/bridge according to the lab analog of the working model. After reduction and modification of the burnout cylinder proceed with the wax-up and casting procedures following the conventional method. Use a reamer tip of identical diameter with the abutment to reduce the margin of the casting body until no further reaming is possible, then check the fit of the prosthesis.



DENTAL CLINIC WORKING

Step7 Prosthesis setting

After checking the prosthesis that has arrived from the lab, remove the temporary prosthesis or protect cap from the mouth. Set the final prosthesis taking care in removing the cement.



Final setting of the prosthesis



When abutment reduction is necessary

Step1 Abutment connection ~ casting

When the vertical dimension or path is not suitable after connecting the rigid abutment the abutment can be modified to solve this problem. (When a large amount of path modification is necessary use a FreeForm ST or Angled abutment) It is possible to alter the path intra-orally and take a direct impression for conventional prosthesis fabrication, but In this case inferior margin fit and over-reduction of the abutment can occur. If you use the components for the prosthesis fabrication procedure as below an exact prosthesis will be completed.



Abutment connection



Path verification



Impression coping connection



Intra-oral protect cap connection



Lab analog connection after impression taking



Working model fabrication



Burn-out cylinder connection and resin-up



Wax-up

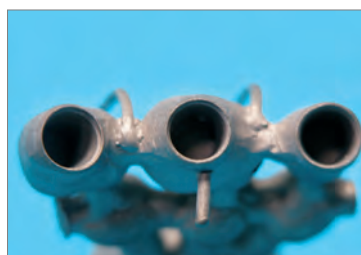

Casting

Step2 Lab analog reduction ~ prosthesis setting



Margin reaming
(Only precious alloy)



Check the fit between the
casting body and lab analog



Lab analog reduction



Connected casting body



Completed porcelain prosthesis



Guide cap fabrication



Intra-oral guide cap setting
and reduction



Final prosthesis setting

Osstem Proper use of Torque wrench and Reamer

Proper usage of Torque wrench



1. Check the torque guide of the abutment
(ex. Transfer abutment mini - 20Ncm)
2. Set a tightening torque at the lower part of the Torque wrench.
*Exactly corresponding to the marking Line.
3. After connecting the Torque wrench and Torque driver, exactly position it on the screw head.
* When connecting: 'IN', when removing: 'Out' should be facing upwards.
4. Press the upper part of the Torque driver and rotate in the direction of the arrow until the neck of the Torque wrench is bent. **After the neck is bent stop applying pressure. Over torque can occur when the force is continued.**

Proper usage of Reamer

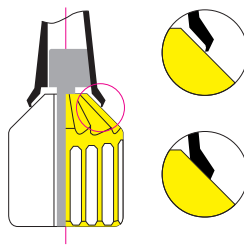
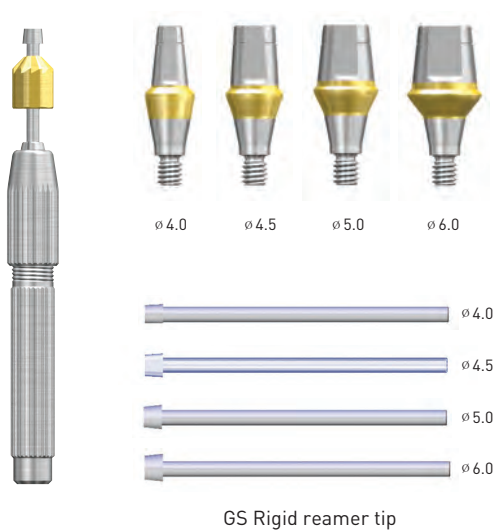

1. After verifying the diameter of the abutment prepare the appropriate reamer tip for connection.
2. After fixing the reamer tip to the prosthesis, turn the reamer bite in the direction of the blade to cut the tip.
3. Continue reaming until the tip is completely removed.
*The reamer cannot be used for nonprecious metal prosthesis, so use the laboratory bur and rubber point to remove the tip.

TS & GS Transfer abutment

• Indication

- Single/bridge/full arch restorations
- All position
- Cement/combi retained restoration

• Contraindication

- When large amounts of abutment modification is necessary.

• Feature & benefit

- A structure of abutment and screw that is more convenient to repair and maintain than Rigid abutment.
- A design that minimizes customizing.
- Two types of impression taking possible : Fixture level/abutment Level
- Margin esthetic effect of gold coloring.

- | | | |
|---------------------|--------------------------|-----------------------|
| • Material | - Abutment : Ti-6Al-4V | - Screw : Ti-6Al-4V |
| • Surface | - Abutment : TiN coating | - Screw : WCC coating |
| • Tightening torque | - Mini : 20Ncm | - Regular : 30Ncm |

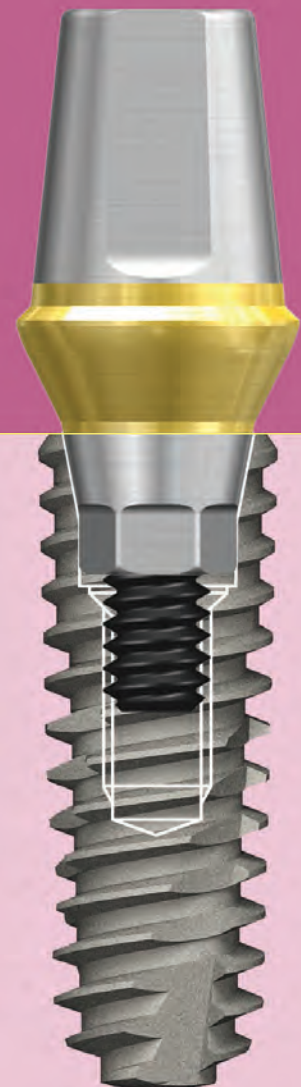

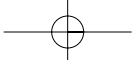

Product list for prosthetic procedure

For fixture level impression





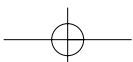



Product list		
Abutment		
Abutment screw		
	Transfer Type	Pick-up Type
Impression coping		
Lab analog		
Driver		
Torque wrench		

- When taking a fixture level impression the abutment is selected on a working model, so the chair time is decreased. Both transfer/pick-up impression is possible and can be selected depending on the preference of the operator or case condition. When the number of installed implants is large, or the path is excessively deflected, however, the tray may not be separable from the impression after taking a pick-up type. Thus, generally using a transfer type is convenient.

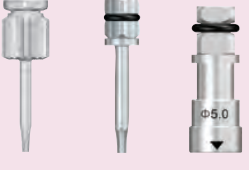

Product list for prosthetic procedure

For abutment level impression

Product list	
Abutment	
Abutment screw	
Protect cap	
Impression coping	
Lab analog	
Burn-out cylinder	
Finishing reamer	
Driver	
Torque wrench	

- When reducing the transfer abutment is unnecessary, an impression may be taken at the abutment level as with a rigid abutment. At this time, Transfer abutment is compatible with rigid component.

Note for prosthetic process

Abutment diameter selection

- The Transfer abutment has 4/5.5/7mm height, and besides the 1/2/3/4/5mm gingival height there are a variety of margin diameters as $\phi 4.5/\phi 5.0/\phi 6.0/\phi 7.0$ considering the prosthesis for each tooth position. It is possible to conveniently fabricate an esthetic prosthesis by referring to the recommendation table below

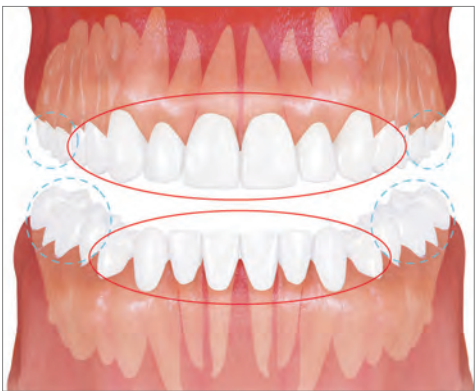

Position	Transfer abutment Diameter
	$\phi 4.5$
	5.0/ $\phi 6.0$

$\phi 7.0$ is used for GS Ultra Wide fixture

Abutment level impression

- With a Rigid abutment it is easy to fabricate a temporary prosthesis/abutment level impression and has exact and convenient prosthesis components which make it advantageous for producing an internal submerged type prosthesis. But it is easy to repair the prosthesis when various problems occur. When using a transfer abutment the screw hole makes it easier to solve these problems. The Rigid abutment and Transfer abutment have an identical upper margin design which makes it possible to use the same impression and prosthesis components, even when the transfer abutment which is easy to repair is used. The prosthetic procedures are carried out in the same manner.

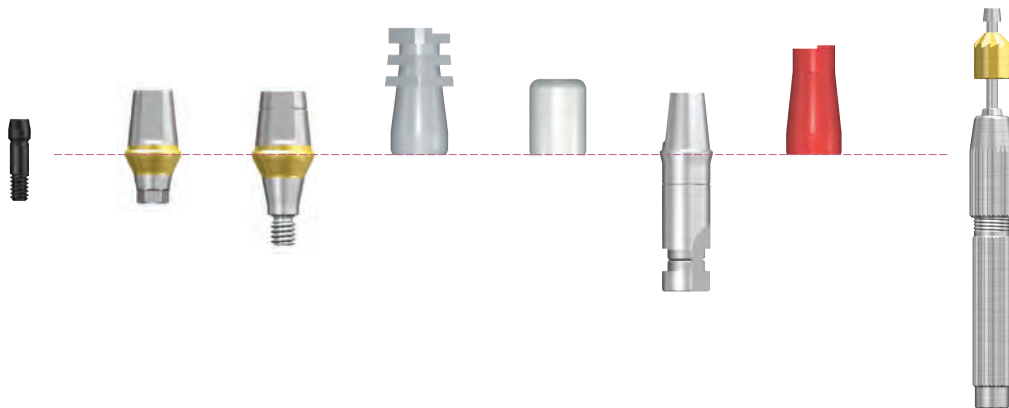

DENTAL CLINIC WORKING

Fixture level impression

Step1 Healing abutment separation

Components & tools

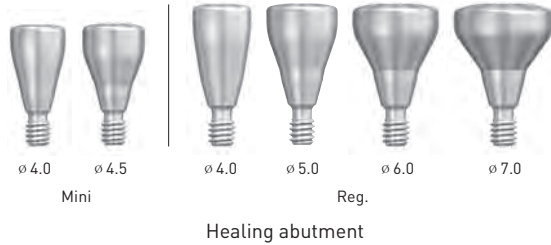

Prosthetic procedure

Separate the Healing abutment using a 1.2 Hex hand driver.



Healing abutment verification



Gently separate the Healing abutment with hand force.



Fixture level impression

Step2 Impression coping connection

■ Fixture transfer impression copings

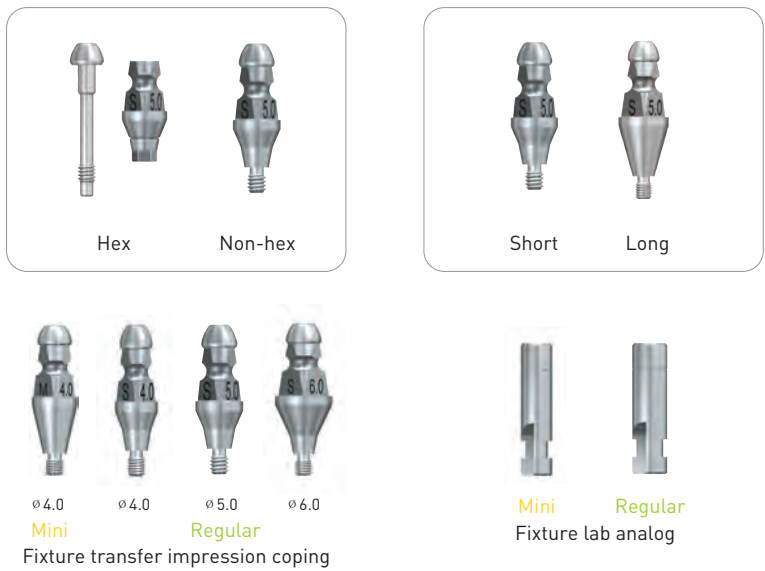

■ Prosthetic procedure

Predict the diameter and type (Hex, Non-Hex) of the abutment to be used and select an impression coping that will be connected using a 1.2 Hex hand driver with hand force. When the vertical dimension is insufficient apply the short feature. We recommend you to block-out the driver hole of the impression coping. It is essential to take a periapical X-ray to verify the exactness of the impression coping connection.



Step3 Impression taking & lab analog connection

First inject impression material around the impression coping to take an impression. Remove the impression body from the mouth after the impression material has set. Then, separate the impression coping from the removed impression body. Connect a fixture lab analog and impression coping of identical connection. Check the triangle-circle structure replicated on the impression and match the internal surface of the coping to reconnect it as it was before impression taking. Remember to check whether the setting is exact after connection.



Impression material injection

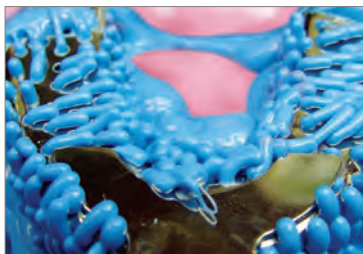

Impression taking



Triangle-circle structure verification

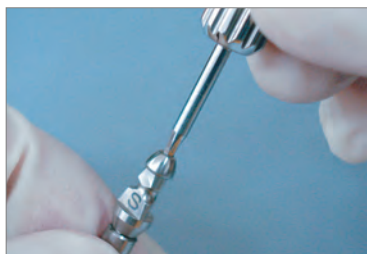

Connecting the coping and lab analog



Repositioned coping with lab analog



Fixture level impression

DENTAL LAB WORKING

Step4 Working model fabrication & abutment selection

Transfer abutments

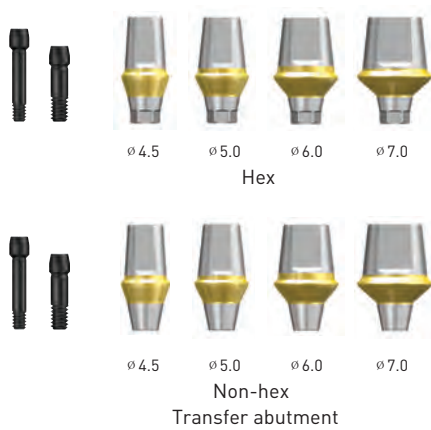

Prosthetic procedure

Select and connect an abutment with suitable features considering gingiva height and interocclusal relationship. The path and position of margin can be modified at the lab following orders from the clinic.



Completed working model



Connect the selected abutment

Step5 Wax-up ~ porcelain build-up

When adjustment of the abutment is completed, proceed with wax-up to casting following conventional methods, and porcelain build up in case of a PFM. Generally, pattern resin that shows little contraction is used for cap fabrication and wax-up is followed.



Resin-cap fabrication



Full wax-up



Cut-back



Casting



Porcelain firing



Completed prosthesis

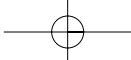

Fixture level impression

Step6 Fabrication of transfer jig

When the prosthesis is finished a transfer jig is made to transfer and connect the abutment on the model inside the mouth in the same condition. It is especially important when using the GS system, which is relatively hard to exactly transfer the abutment. It is mandatory for non-hex abutment, and even when using a hex type the jig helps you to exactly settle and verify the abutment In the clinic. Remove the gum on the model, and make it with pattern resin after cleansing the abutment surface.



Transfer jig fabrication

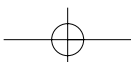

DENTAL CLINIC WORKING

Step7 Prosthesis setting

Tools

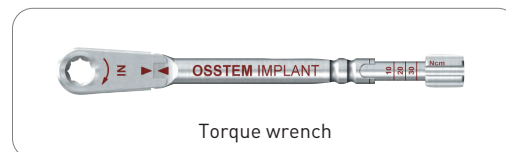

Prosthetic procedure

Connect the abutment intra-orally in the same condition using a Transfer Jig. Take a periapical x-ray to check the connection of the abutment. Set the tightening torque at 20Ncm for a mini abutment and 30 Ncm for Regular and tighten the screw.



Abutment connection using a jig



Abutment screw tightening



Final prosthesis setting



Abutment level impression

Step1 Abutment connection ~ wax-up

If the fixture path is good and Transfer abutment reduction is unnecessary, the components for the Rigid abutment can be used for a abutment level impression and prosthesis fabrication.



Abutment screw tightening



Rigid impression coping connection



Impression taking



Impression body verification



Rigid lab analog connection



Rigid protect cap connection



Working model fabrication



Burn-out cylinder connection



Wax-up

Step2 Casting ~ prosthesis setting



Cut-back



Margin reaming



Connected casting body



Completed prosthesis



Final prosthesis setting

TS & GS Angled abutment

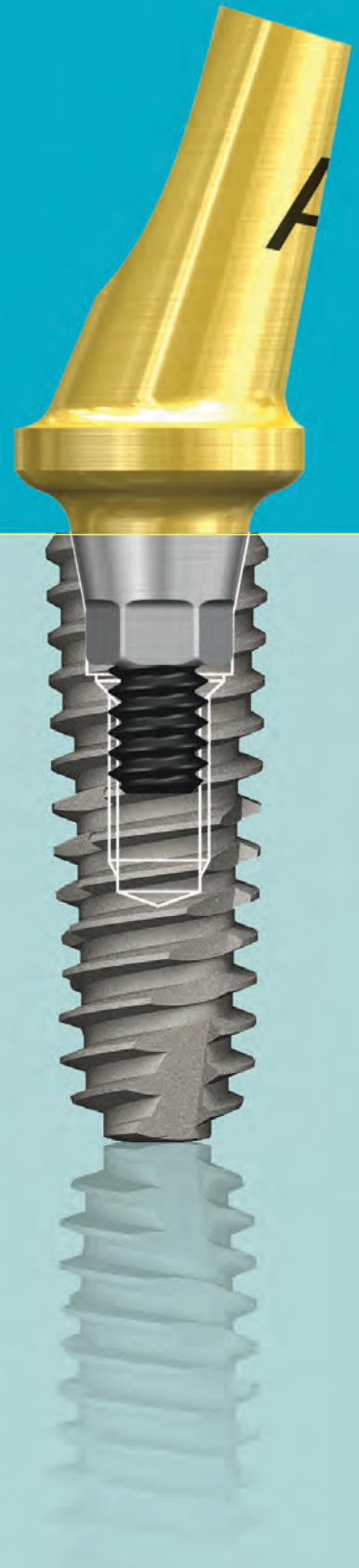

• **Indication**

- Single/bridge restorations
- When path modification is necessary.
- Cement/Combi retained restoration

• **Contraindication**







- Posterior bridge crown (Only Angled abutment)

• **Feature & benefit**

- 17° Axial angulation
- Minimize the amount of reduction with A/B two hex types
- Margin esthetic effect with gold coloring

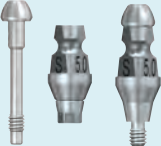
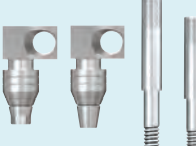
- | | | |
|----------------------------|--------------------------|-----------------------|
| • Material | - Abutment : Ti-6Al-4V | - Screw : Ti-6Al-4V |
| • Surface | - Abutment : TiN coating | - Screw : WCC coating |
| • Tightening torque | - Mini : 20Ncm | - Regular : 30Ncm |

Product list for prosthetic procedure

Product list		
Abutment selector		
Abutment		
Abutment screw		
Impression coping	Transfer Type	Pick-up Type
		
Lab analog		
Driver		
Torque wrench		

- When using a hex type abutment the internal hex structure of the fixture can cause interference between the Angled abutment and adjacent teeth and tissue. Before selecting an angled abutment at the clinic or lab, choose an appropriate A/B Hex type using a selector to minimize reduction during prosthesis fabrication.

Note for prosthetic process

Path modification with Angled abutment

- In cases such as the anterior part where path modification according to anatomical structure and path compensation for bridge crown misalignment is necessary, the Angled abutment can be useful. The GS Angled abutment has a 17° axial taper and 6° tapered body which allows path compensation up to 23° without abutment reduction. But the single use of an angled abutment for the restoration of a posterior bridge case is prohibited since over cantilever force may be produced.

Angle	10°	17°	23°
Design concept	Posterior 1° milling	No undercut	No undercut

Application of Angled abutment selector.

- The GS angled abutment has two directions: A/B. This enables choosing an appropriate direction after the abutment has been connected; thus enabling the minimization of the amount of reduction.
- An abutment with an appropriate direction may be chosen intra-orally or on the model using an angled abutment selector.

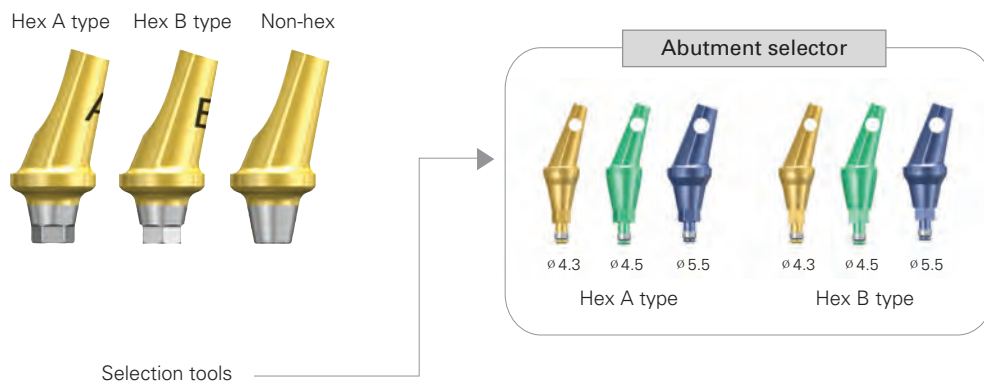

DENTAL CLINIC WORKING

Fixture level impression

Step1 Healing abutment separation

Components & tools

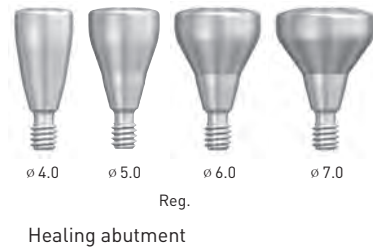
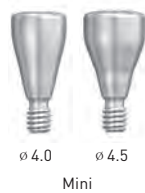
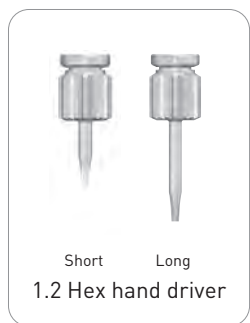

Prosthetic procedure

Separate the Healing abutment using a 1.2 Hex hand driver.



Verification of Healing abutment



Gently separate the Healing abutment with hand force.



Fixture level impression

Step2 Abutment type selection

Angled abutment selectors



GS Angled abutment selector

Prosthetic procedure

When applying a hex type abutment by using an abutment selector, you can choose an appropriate abutment in the lab or clinic. When selecting an abutment at the clinic connect both the A/B selector and decide a feature before taking an impression and at the lab try it on the working model.

Good



A type selector connection (good)



B type selector connection (not-good)

Step3 Impression

Fixture transfer impression copings

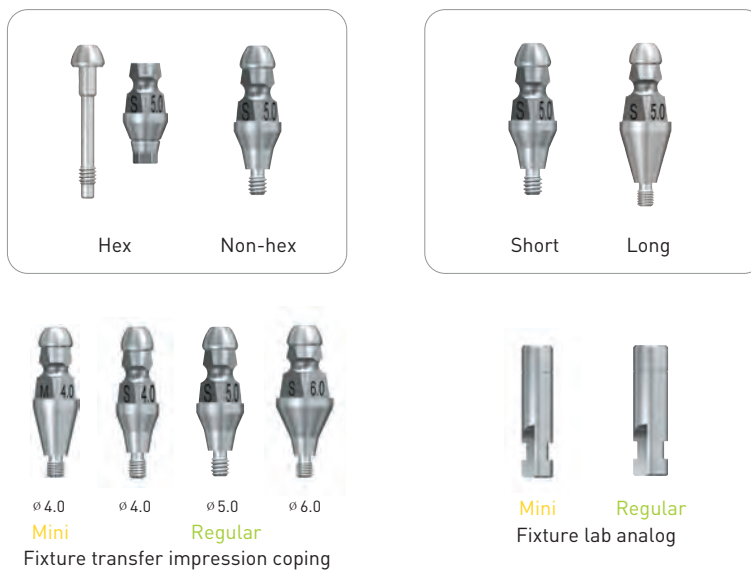

Prosthetic procedure

Predict the diameter and type (hex, non-hex) of the abutment to be used and select an impression coping that will be connected using a 1.2 Hex hand driver with hand force. When the vertical dimension is insufficient apply the short feature. We recommend you to block-out the driver hole of the impression coping. It is essential to take a periapical x-ray to verify the exactness of the impression coping connection.

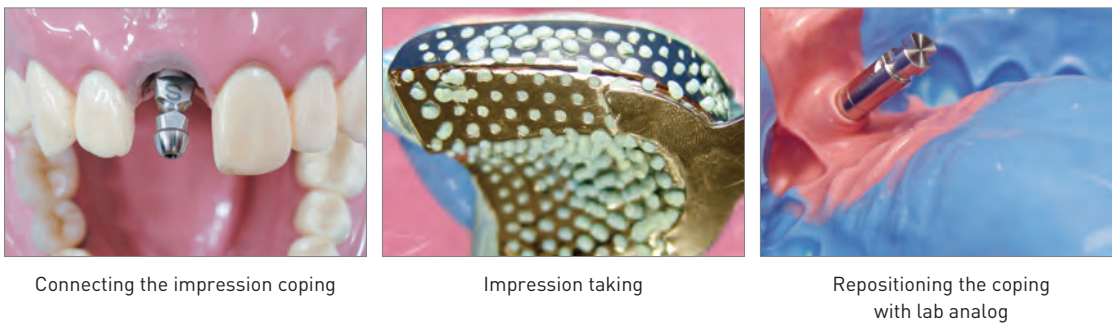



Angled abutment

Fixture level impression

DENTAL LAB WORKING

Step4 Working model fabrication & abutment selection

Angled abutments

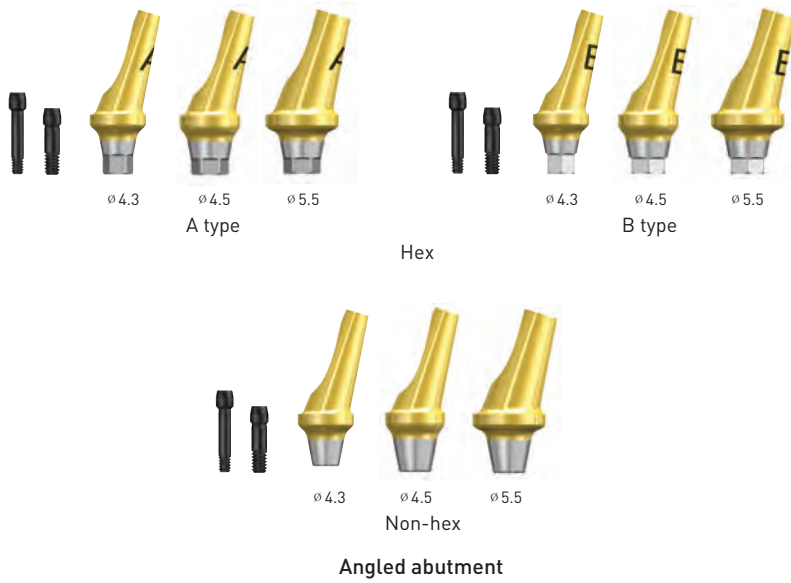

Prosthetic procedure

Make a working model from the impression body following the conventional method and connect the abutment. If the abutment hex type has not been selected at the clinic it is possible to do it with a selector on the model. By choosing the correct abutment the amount of reduction will be minimized and quick and exact prosthesis fabrication is made possible.

Good



A type selector connection (good)



B type selector connection (not-good)

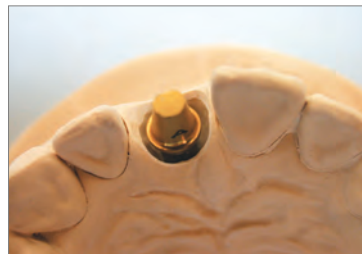

Connect the selected abutment

Step5 Abutment modification ~ porcelain build-up

Eliminate the undercut area with a stone wheel and adjust the abutment. Complete the conventional steps from wax-up to casting, and in the case of a PFM, porcelain build up.

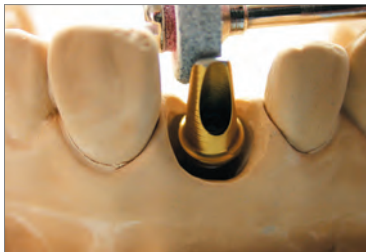

Abutment modification



Path verification



Wax-up & cut-back
(labial)

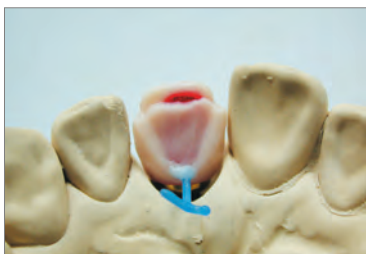

Wax-up & cut-back
(lingual)



Casting & opaque



Completed prosthesis



Fixture level impression

DENTAL CLINIC WORKING

Step6 Prosthesis setting

Tools

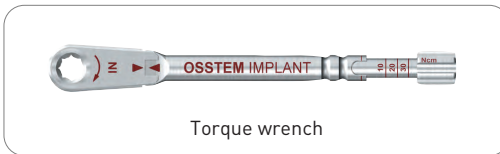
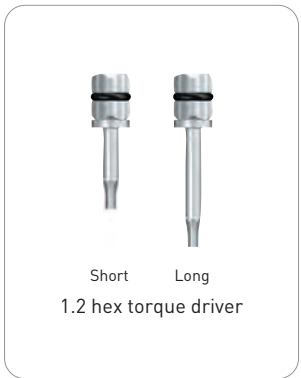

Prosthetic procedure

Connect the abutment intra-orally after verifying the abutment direction on the model. Take a periapical x-ray to check the connection of the abutment. Set the tightening torque at 20 Ncm for a mini abutment and 30 Ncm for Regular and tighten the screw.



Abutment connection



Abutment screw tightening



Final prosthesis setting

TS & GS ZioCera abutment

- **Indication**

- Single/bridge restorations
- Anterior area
- Cement/Screw retained restoration

- **Contraindication**

- Molar area crown & bridge

- **Feature & benefit**

- Zirconia material of superior strength and biocompatibility
- Straight/17° angled two types that are more convenient for the operator.
- A design that minimizes customizing.
- Natural dentin color abutment shade establishment
- A design easy to customize



- **Material** - Abutment : Zirconia - Screw : Ti-6Al-4V

- **Surface** - Screw : WCC coating

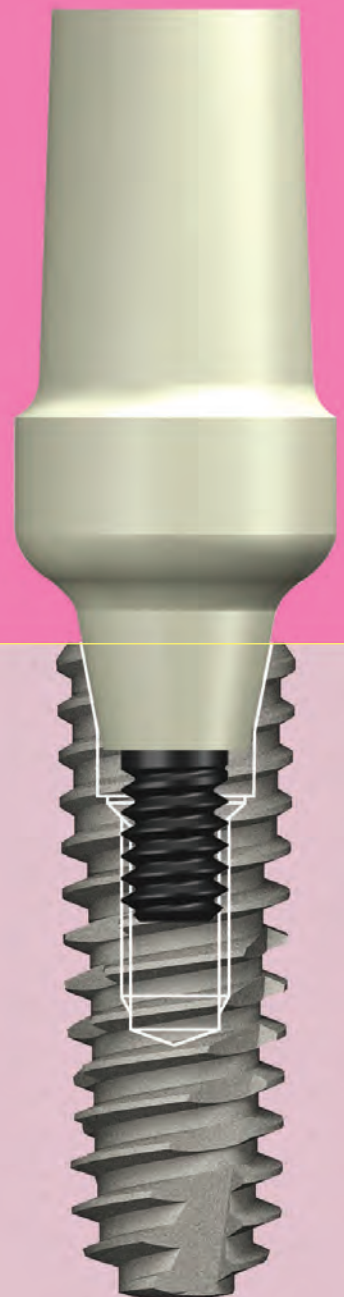
- **Tightening torque** - Mini : 20Ncm - Regular : 30Ncm

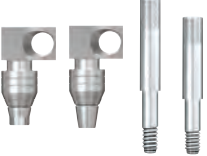

Product list for prosthetic procedure

Product list		
Abutment		
Abutment screw		
	Transfer Type	Pick-up Type
Impression coping		
Lab analog		
Driver		
Torque wrench		

- In such cases as the maxillary anterior portion where abutment path modification is necessary because of anatomical structures, by using the angled type ZioCera abutment you can minimize abutment customizing and make it easier to apply a screw type prosthesis. The straight type ZioCera abutment enables free customization to various shapes when abutment path modification is unnecessary.

Note for prosthetic process

Cement retained type restoration with ZioCera abutment

- The zirconia abutment is usually used as a scaffold structure for all ceramic prostheses of the cement-retained type.

After customizing the abutment on the working model using an exclusive bur for zirconia, fabricate an appropriate inner ceramic coping considering the condition of the patient and use the exclusive porcelain powder for buildup to gain the most aesthetic implant prosthesis. When reducing the abutment, use a bur exclusive for zirconia that is not rough. Spray water or wet the abutment during the procedure.

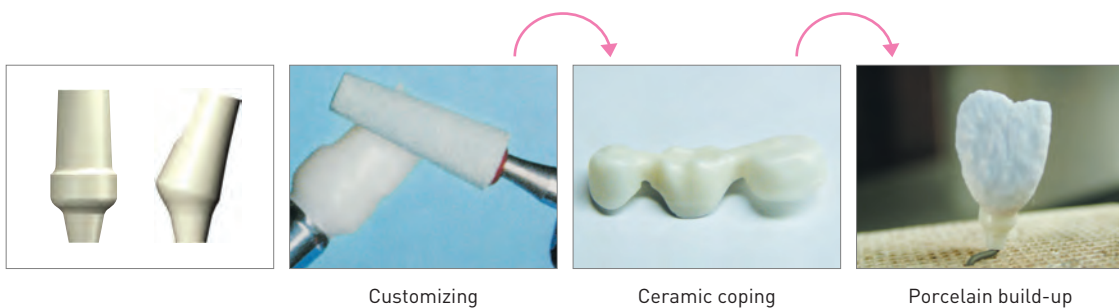

Screw retained type restoration with ZioCera abutment

- When there is 1~1.5mm space between the adjacent tooth after abutment connection you can fabricate a screw retained type prosthesis using a ZioCera abutment. In case of a screw retained type, there is no need of a coping, making it an economical and quick prosthesis fabrication is possible. In such cases as the maxillary anterior portion where an angled abutment is necessary because of anatomical structures, by using an angled ZioCera abutment it is more convenient to fabricate a screw retained type prosthesis.

(however, the porcelain must be zirconia exclusive powder.)

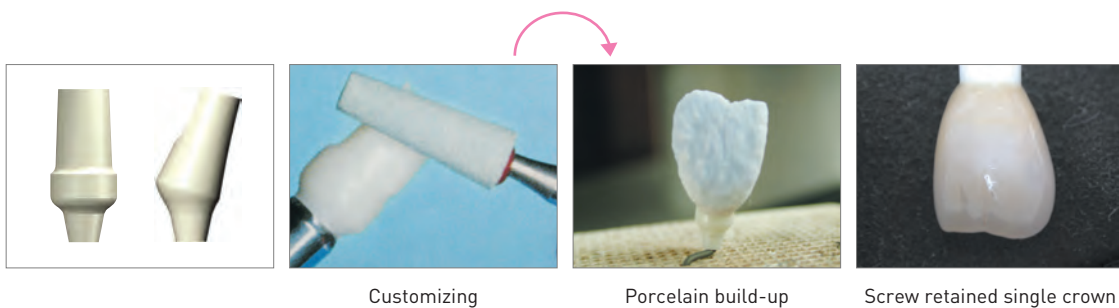

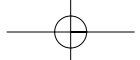

ZioCera angled abutment

Cement retained restoration

DENTAL CLINIC WORKING

Step1 Healing abutment separation

Components & tools

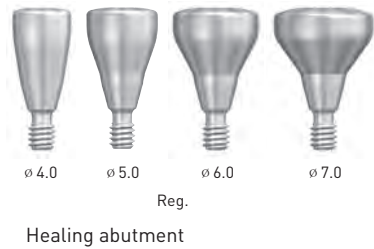
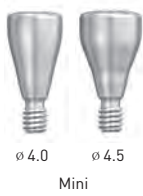
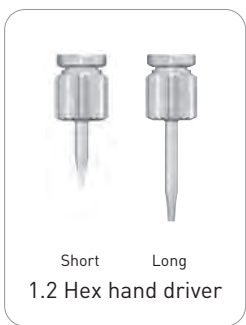

Prosthetic procedure

Separate the Healing abutment using a 1.2 Hex hand driver.



Healing abutment verification



Gently separate the Healing abutment with hand force.

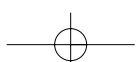

Step2 Impression

Fixture transfer impression coping

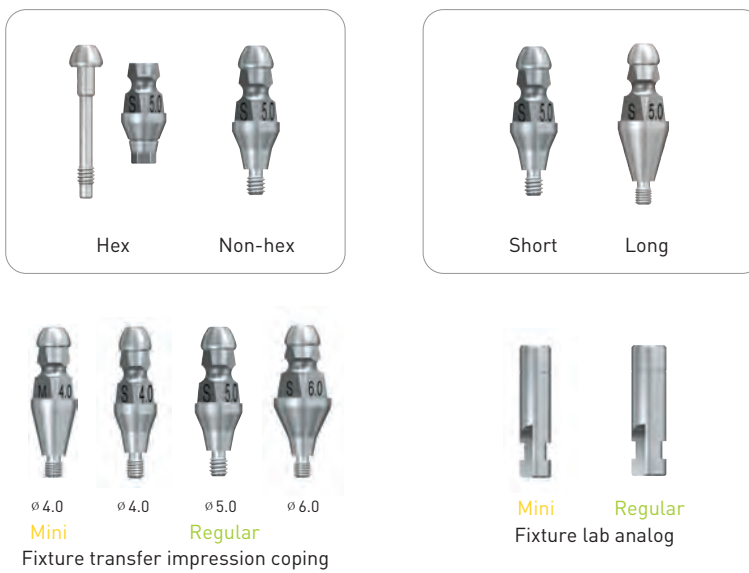

Prosthetic procedure

Predict the diameter and type (hex, non-hex) of the abutment to be used and select an impression coping that will be connected using a 1.2 Hex hand driver with hand force. When the vertical dimension is insufficient apply the short feature. We recommend you to block-out the driver hole of the impression coping. It is essential to take a periapical x-ray to verify the exactness of the impression coping connection.

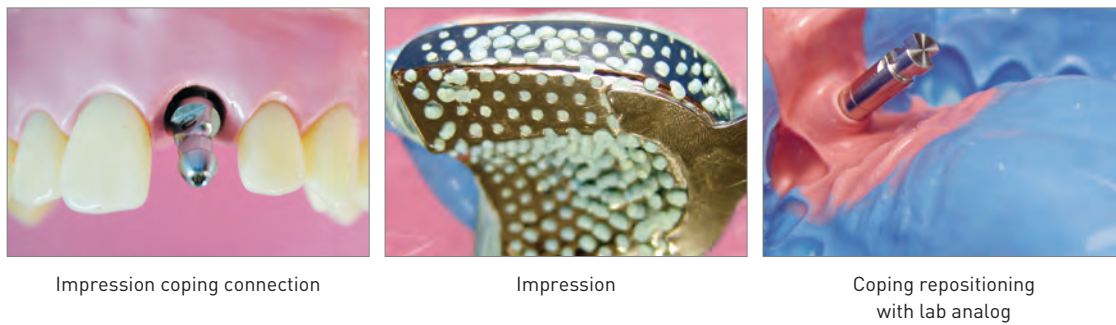

ZioCera angled abutment

Cement retained restoration

DENTAL LAB WORKING

Step3 Working model fabrication & abutment selection

ZioCera & ZioCera Angled abutments



Straight type

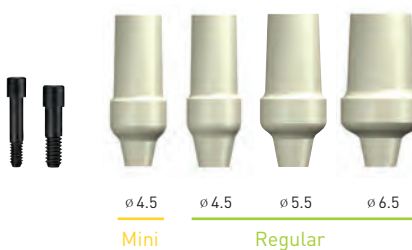

Angled type

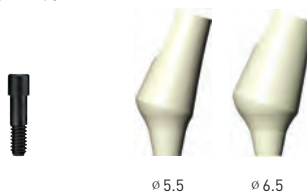

ZioCera abutment

Prosthetic procedure

Make a working model from the impression body following the conventional method and connect the abutment. Check the path on the model and select an appropriate abutment.

Since the ZioCera abutment is more difficult to customize than the titanium abutment, it is important to minimize tool wear and reduce time by choosing the correct abutment.



Abutment connection on working model



Customize area verification



cf) Straight type connection

Step4 Abutment modification ~ porcelain build-up

Unlike the titanium abutment you must use exclusive polishing tools for ZioCera abutment customizing. Use a soft-/medium-level bur and reduce the thermal shock by spraying water or wetting the abutment. The ZioCera abutment is for all ceramics; thus, unlike PFM, fabricate a ceramic coping. Fabricate an appropriate ceramic coping considering the adjacent space and transparency and complete the final prosthesis with porcelain exclusive for the corresponding coping.



Abutment modification I



Abutment modification II

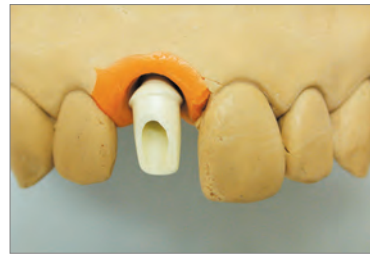

Customized abutment



Alignment verification



Internal crown wax-up

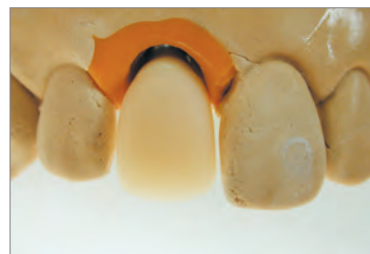

Completed ceramic coping



Porcelain build-up



Completed all ceramic

ZioCera angled abutment

Cement retained restoration

DENTAL CLINIC WORKING

Step5 Prosthesis setting

Tools

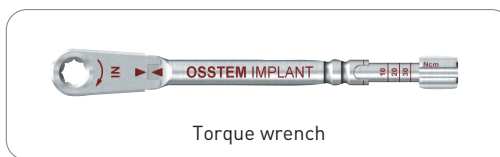
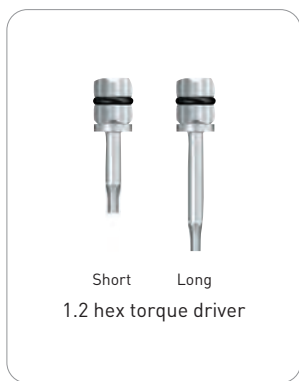

Prosthetic procedure

Connect the abutment intra-orally after verifying the abutment direction on the model. Take a periapical x-ray to check the connection of the abutment. Set the tightening torque at 20 Ncm for a mini butment and 30 Ncm for Regular and tighten the screw.



Abutment connection



Abutment screw tightening



Final prosthesis setting

DENTAL CLINIC WORKING

Screw retained restoration

Step1 Healing abutment separation

Components & tools

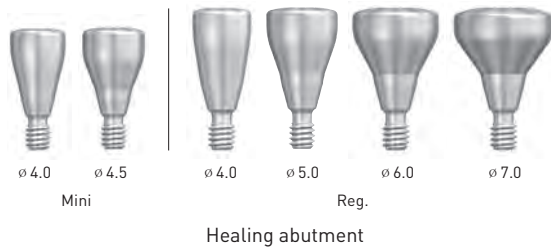
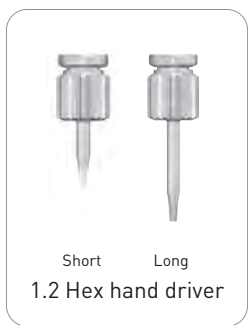

Prosthetic procedure

Separate the Healing abutment using a 1.2 Hex hand driver.



Healing abutment verification



Gently separate the Healing abutment with hand force.



Screw retained restoration

Step2 Impression

Fixture pick-up impression coping

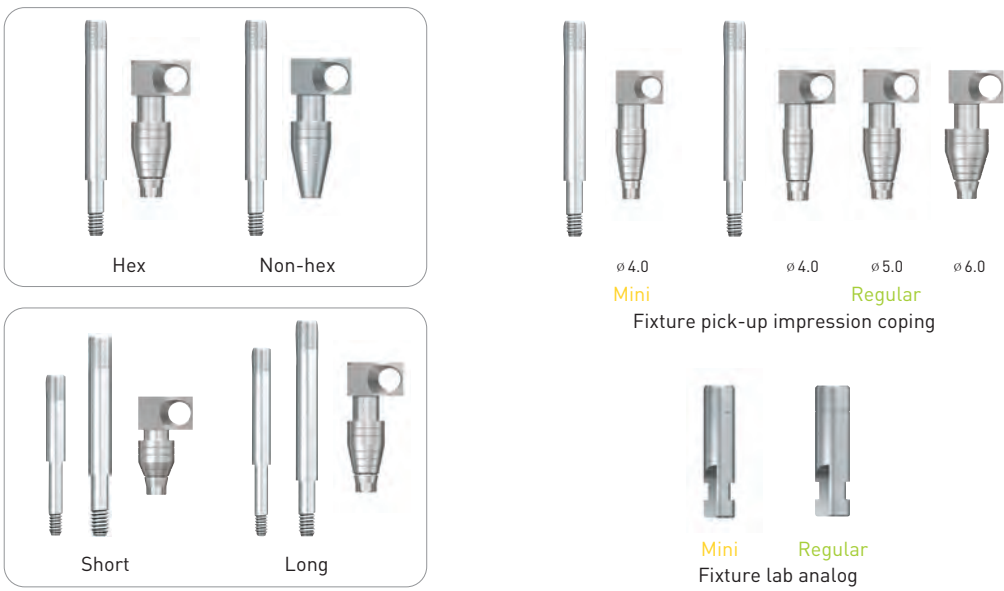

Prosthetic procedure

Prepare a custom open tray and predict the diameter and type (hex, non-hex) of the abutment to be used and select an impression coping. Connect the guide pin using a 1.2 Hex hand driver with hand force. It is essential to take a periapical x-ray to verify the exactness of the impression coping connection. First inject impression material around the hole of the upper part of the coping and separate the impression body by loosening the guide pin after the material has set. Connect a fixture lab analog of identical connection.

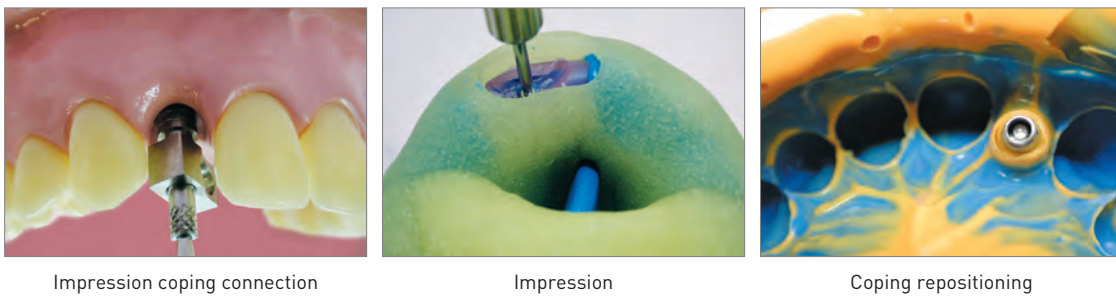

DENTAL LAB WORKING

Step3 Working model manufacture & abutment selection

ZioCera & ZioCera Angled abutments



Straight type

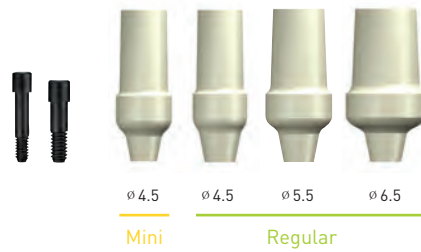

Angled type

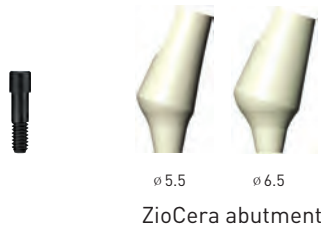

Prosthetic procedure

Make a working model from the impression body following the conventional method and connect the abutment. Check the path on the model and select an appropriate abutment.

Since the ZioCera abutment is more difficult to customize than the titanium abutment, it is important to minimize tool wear and reduce time by choosing the correct abutment.



Abutment connection
on working model



Marked
customizing area

ZioCera abutment

Screw retained restoration

Step4 Abutment modification ~ porcelain build-up

After customizing the ZioCera abutment when the space left between the opposing tooth and adjacent tooth is less than 1~1.5mm you can fabricate a screw retained type prosthesis using zirconia exclusive porcelain. In this case, unlike the cement retained type, there is no need to make a separate ceramic coping so the prosthesis fabrication procedure is economical and quick. When the porcelain thickness exceeds 2mm the porcelain may crack and then a cement retained type prosthesis must be made.



Abutment modification I



Abutment modification II

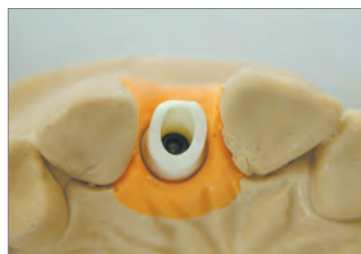

Customized abutment

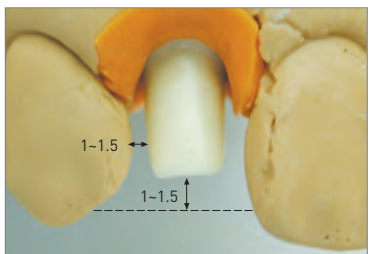

Space verification

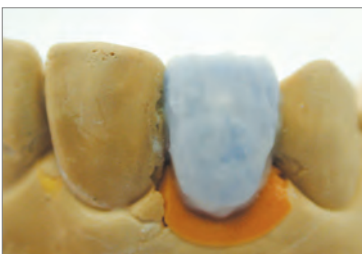

Porcelain build up (Labial)



Porcelain build up (Lingual)



Firing completed



Completed screw retained restoration

DENTAL CLINIC WORKING

Step5 Prosthesis setting

Tools

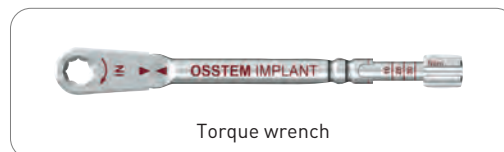

Prosthetic procedure

Connect the prosthesis considering the contact point of the adjacent teeth.

It is essential to take a periapical x-ray to check the exactness of the connection. When a mini abutment has been used set the tightening torque at 20 Ncm, and 30 Ncm for a Regular feature and tighten the screw.



Abutment connection

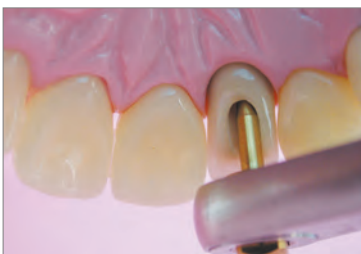

Abutment screw tightening



Final prosthesis setting

TS & GS

FreeFormST

abutment

- **Indication**

- Single/bridge/full arch restorations
- All position
- When fabricating large-volume prosthesis or extensive path modification is necessary
- Cement/Combi retained restoration

- **Feature & benefit**

- The large abutment volume allows free customization and secures appropriate support after reduction.
- Margin esthetic effect of gold coloring.

- **Material**

- Abutment : Ti -6Al-4V - Screw : Ti-6Al-4V

- **Surface**





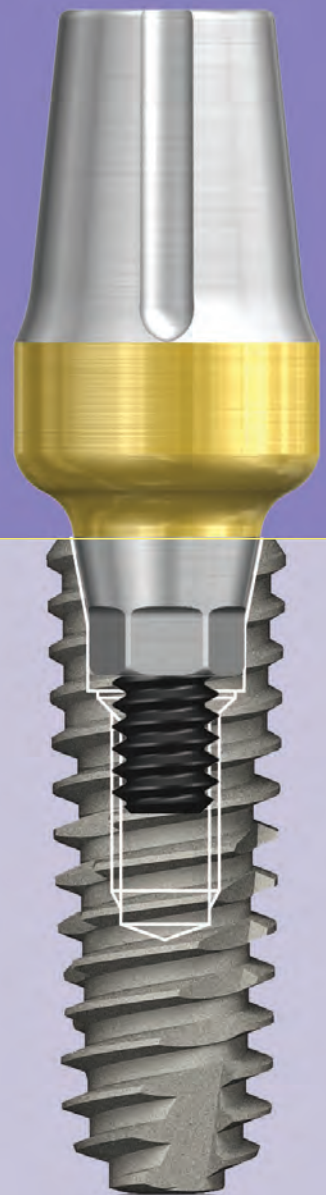

- Abutment : TiN coating - Screw : WCC coating

- **Tightening torque**

- Mini : 20Ncm - Regular : 30Ncm

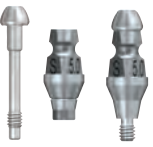

Product list for prosthetic procedure

Product list	
Abutment	
Abutment screw	<div style="display: flex; justify-content: space-around;"> <div style="text-align: center;">  <p>Transfer Type</p> </div> <div style="text-align: center;">  <p>Pick-up Type</p> </div> </div>
Impression coping	<div style="display: flex; justify-content: space-around;"> <div style="text-align: center;">  <p>Transfer Type</p> </div> <div style="text-align: center;">  <p>Pick-up Type</p> </div> </div>
Lab analog	
Driver	
Torque wrench	

- The limitations of prosthesis fabrication that occur from Transfer abutment/Angled abutment usage can be overcome by FreeForm ST abutments. It can be used through customizing for expression of the gingival scallop form, overcoming bridge misalignment and fabrication of single crowns bigger than normal size.

Note for prosthetic process

FreeForm ST abutment usage

- The FreeForm ST abutment's large volume and design is useful for margin configuration establishment and path modification convenience. The $\varnothing 4.0$ diameter FreeForm abutment can be customized and used for areas with narrow interdental space such as the mandibular anterior area.



DENTAL CLINIC WORKING

Cement retained restoration

Step1 Healing abutment separation

Components & tools

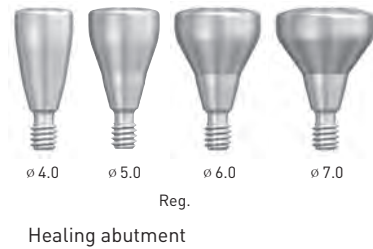
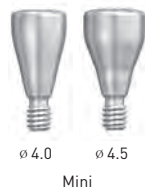
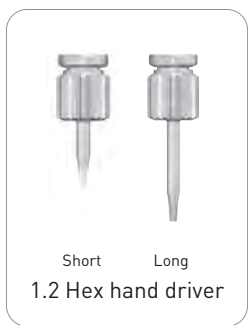

Prosthetic procedure

Separate the Healing abutment using a 1.2 Hex hand driver with hand force.



Healing abutment verification



Gently separate the Healing abutment manually



Cement retained restoration

Step2 Impression

Fixture pick-up impression copings

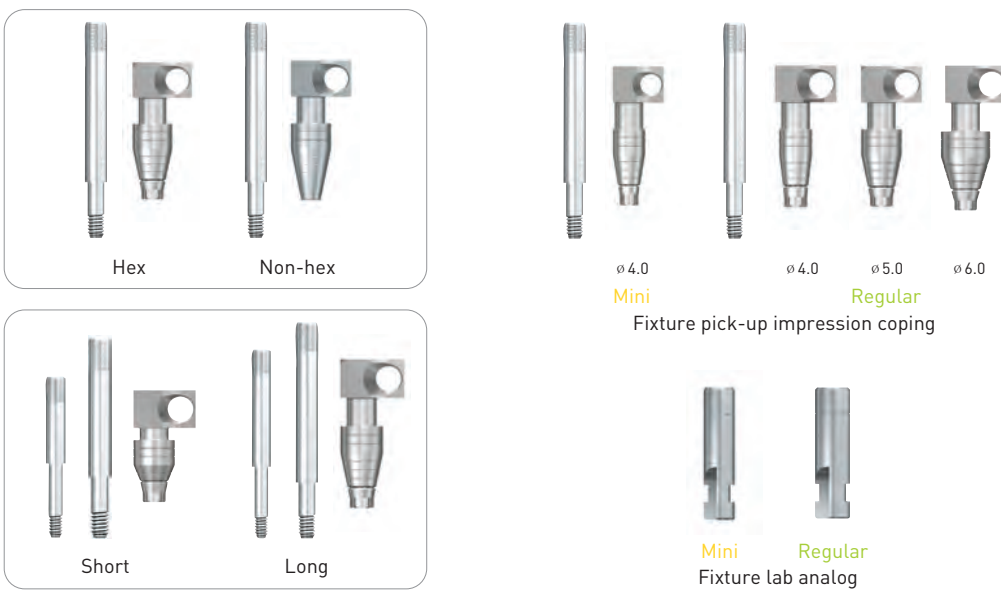

Prosthetic procedure

Prepare a custom open tray, predict the vertical space, abutment diameter, type (hex, non-hex) and select an impression coping. Gently connect the guide pin using a 1.2 Hex hand driver manually. Do not forget to take an x-ray to check the exactness of the coping connection. Inject impression material around the hole of the upper part of the coping and loosen the guide pin after the material has set to remove the impression body. Connect a fixture lab analog of identical connection.



DENTAL LAB WORKING

Step3 Working model fabrication & abutment modification

FreeForm ST abutments

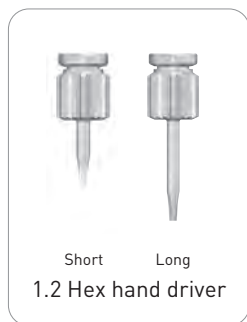

Prosthetic procedure

Make a working model from the impression body following conventional methods and connect the abutment. Connect a FreeForm ST abutment and adjust the path and customize the form. Fabrication of a precise transfer jig to be used as a guide for additional prosthetic work is mandatory after customizing is completed when a non-hex type has been used.



Completed working model



Path adjustment



Transfer jig fabrication



Cement retained restoration

Step4 Wax-up ~ prosthesis completion

Go through the conventional steps for resin, wax-up and casting.
Deliver the completed prosthesis with the transfer jig to the clinic.

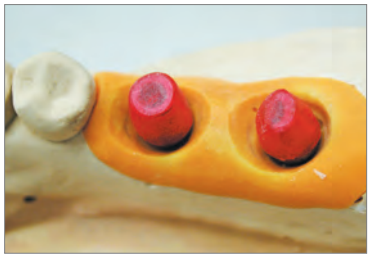

Resin-up



Full wax-up



Buccal opening



Verification of casting body fit



Completed prosthesis

DENTAL CLINIC WORKING

Step5 Prosthesis setting

Tools

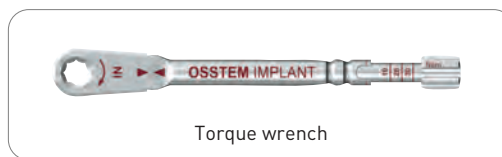

Prosthetic procedure

Connect the abutment intra-orally in the same condition as with the model using the transfer jig. Check whether the torque is set to an appropriate level, then remove the transfer jig and place the prosthesis. Always verify the exactness of the connection by taking an x-ray after the final connection of the abutment.



Abutment connection



Abutment screw tightening



Transfer jig removal

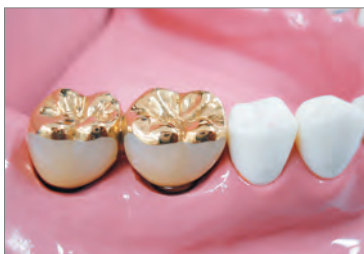

Final prosthesis setting



Cement retained restoration

DENTAL CLINIC WORKING

Step1 Healing abutment separation

Components & tools

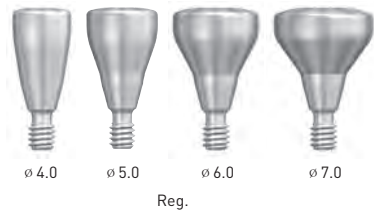
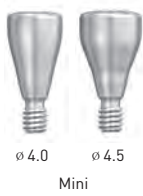

Prosthetic procedure

Separate the Healing abutment using a 1.2 Hex hand driver with hand force.



Healing abutment verification



Gently separate the Healing abutment manually

Step2 Impression

Fixture transfer impression coping

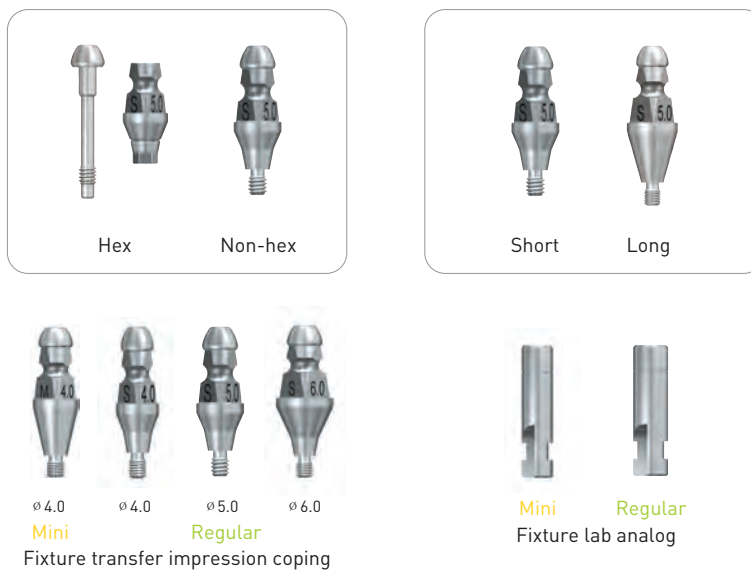

Prosthetic procedure

Predict the diameter and type (hex, non-hex) of the abutment to be used and select an impression coping that will be connected using a 1.2 Hex hand driver with hand force. When the vertical dimension is insufficient apply the short feature. We recommend you to block-out the driver hole of the impression coping. It is essential to take a periapical x-ray to verify the exactness of the impression coping connection.

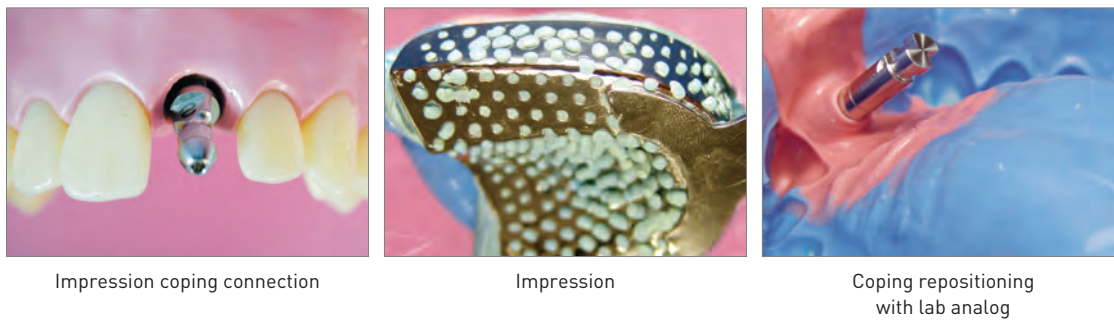

TS & GS GoldCast abutment

- **Indication**

- Single/bridge/full arch restorations
- All position
- When fabricating a cement-retained prosthesis is difficult due to the limitations of spaces and paths
- Prosthesis whose precise customization is necessary
- Cement/screw/Combi retained restoration

- **Contraindication**

- Non precious alloy casting

- **Feature & benefit**

- Enables fabricating a prosthesis with a minimum of 4 mm vertical space from the fixture installation level
- Non-hex feature composition for bridge cases

- **Material**

- Abutment : Au-Pt alloy + POM
- Screw : Ti-6Al-4V

- **Surface**







- Screw : WCC Coating

- **Tightening Torque**

- Mini : 20Ncm
- Regular : 30Ncm



Product list for prosthetic procedure

Product list		
Abutment		
Abutment screw		
	Transfer Type	Pick-up Type
Impression coping		
Lab analog		
Driver		
Torque wrench		

- The goldcast abutment allows free and easy customization; a prosthesis of any type, screw/cement/combi may be fabricated through gold casting.
- Problems that limit the fabrication of a conventional prosthesis may be addressed, such as the anterior region where precise customization is necessary and posterior cases with narrow vertical space.

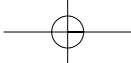

Note for prosthetic process

■ TS & GS GoldCast abutment

- When a cement retained type prosthesis is impossible because of limitations in vertical space between the opposing tooth, a screw retained type must be made. A prosthesis can be fabricated 4mm space from the fixture level with the GoldCast abutment.

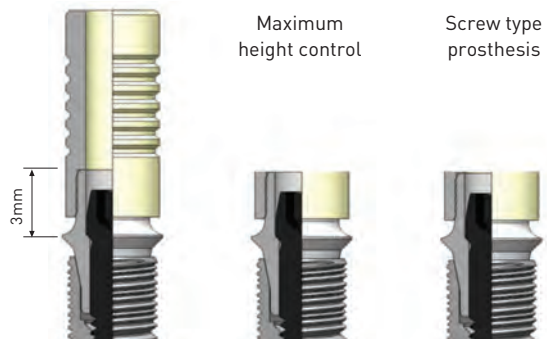

■ Screw Retained type restoration for TS & GS

- Compared to the SS/US System it is difficult to fit screw retained type prosthesis with the TS & GS system which is an internal submerged type. It can be impossible to gain a passive fit with a hex typed GoldCast abutment when the path is wrong in a bridge case or difficult to connect the prosthesis. A non-hexed type must be used for a bridge and the passivity of the fit must be checked with an x-ray. Use a Convertible abutment when the path error exceeds 22° .

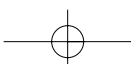
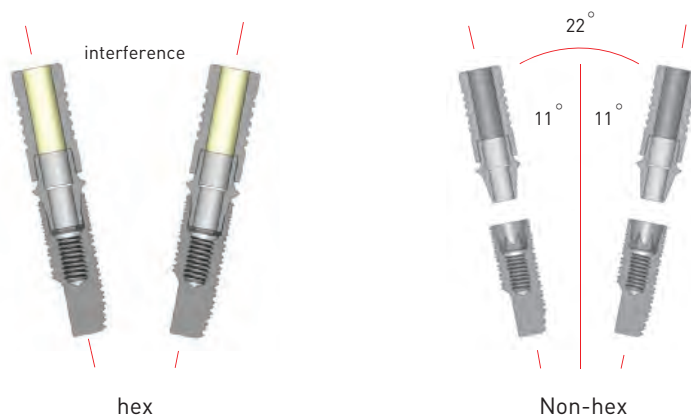

DENTAL CLINIC WORKING

Step1 Healing abutment separation

Components & tools



Cover screw



Healing abutment

Prosthetic procedure

Separate the Healing abutment using a 1.2 Hex hand driver with hand force.



Healing abutment verification



Gently separate the
Healing abutment manually



Screw retained restoration

DENTAL CLINIC WORKING

Step2 Impression

Fixture pick-up impression coping

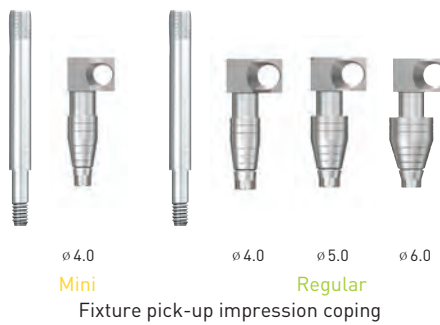
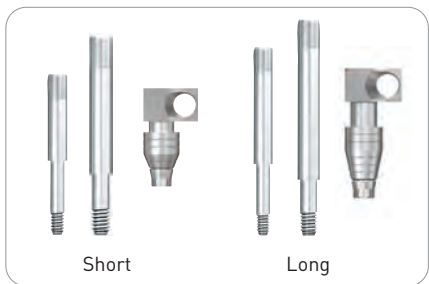
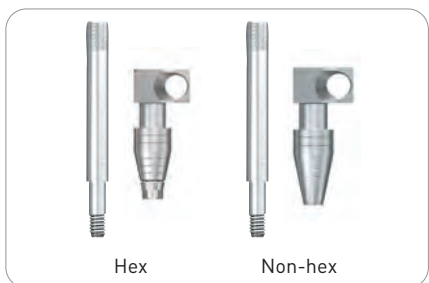

Prosthetic procedure

Prepare a custom open tray, predict the vertical space, abutment diameter, type (hex, non-hex) and select an impression coping. Gently connect the guide pin using a 1.2 Hex hand driver manually. Do not forget to take a x-ray to check the exactness of the coping connection. Inject impression material around the hole of the upper part of the coping and loosen the guide pin after the material has set to remove the impression body. Connect a fixture lab analog of identical connection.



Impression coping connection



Impression



Lab analog connection

Step3 Working model fabrication & abutment modification

GoldCast abutments

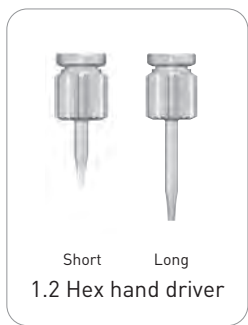

Prosthetic procedure

Make a working model from the impression body following conventional methods and connect the abutment. Select a non-hexed type for a bridge case. Eliminate the plastic area considering prosthesis fabrication space and path.



Abutment connection



Height control

GoldCast abutment

Screw retained
restoration

DENTAL LAB WORKING

Step4 Wax-up ~ prosthesis completion

While maintaining the screw hole do wax-up on the abutment after finishing height adjustment and customizing. It is convenient to use the guide pin of the pick-up impression coping. Cast the precious alloy metal following appropriate procedures for the gold crown/PFG. Non-precious metal alloy may damage the abutment and its use is prohibited.



Step5 Prosthesis setting

Tools

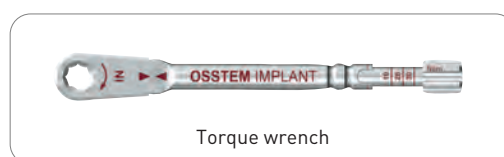
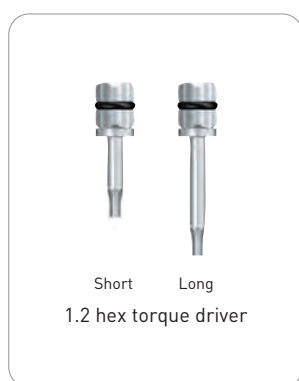

Prosthetic procedure

Check the prosthesis and verify the recommended tightening torque.

Set the torque at 20 Ncm for mini and 30 Ncm for Regular and connect the final prosthesis. Insert cotton into the screw hole on the occlusal surface and final block out with resin.



Prosthesis connection



Abutment screw tightening



Hole block-out

TS & GS Convertible abutment

• Indication

- Single/bridge/full arch restorations
- All position
- Bridge case with a wrong path
- Framework for bar overdenture
- Screw/Combi retained restoration

• Feature & benefit

- Path compensation up to 60°. (based on two fixtures)
- Advanced convenience from four prosthesis options, Combi/Angled/Gold/Plastic.
- Abutment connection using carrier
- Margin esthetic effect from gold coloring.

• Material

- Convertible abutment : Ti-6Al-4V
- Combi/Angled cylinder : Ti CP-Gr3
- GoldCast cylinder : Au-Pt alloy + POM
- Plastic cylinder : POM
- Cylinder Screw : Ti-6Al-4V

• Surface







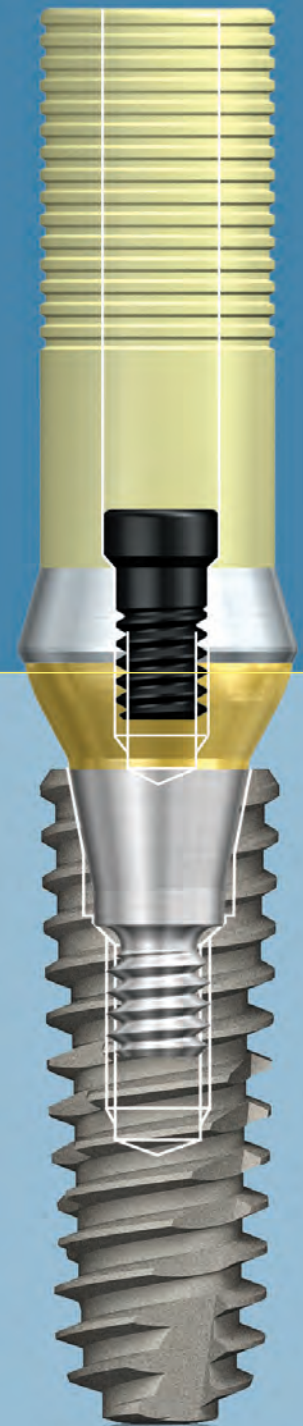
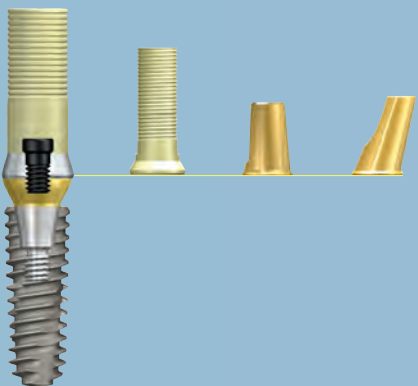

- Abutment & cylinder : TiN coating
- Screw : WCC coating

• Tightening torque

- Abutment : 30Ncm
- Cylinder Screw : 20Ncm



Product list for prosthetic procedure

Product list		
Abutment		
Impression coping	Transfer Type	Pick-up Type
		
Lab analog		
Cylinder		
Cylinder screw		
Polishing protector		
Driver		
Torque wrench		

- The Convertible abutment is a 3-piece composed of abutment + cylinder + cylinder screw.
You must prepare an exclusive impression coping and lab analog that is possible to take an abutment level impression since the impression is taken through transforming the internal connection structure to an external one.

Note for prosthetic process

TS & GS Convertible abutment connection

- The Convertible abutment can be useful in path compensation for bridge prostheses. When fabricating a screw type prosthesis/combi type prosthesis with a hole on the occlusal surface a non-hexed type 2-piece abutment such as Transfer/GoldCast abutment can compensate the path up to 22°. Using a Convertible abutment enables path compensation up to 60° in case of long Bridge and a large amount of path deviation.

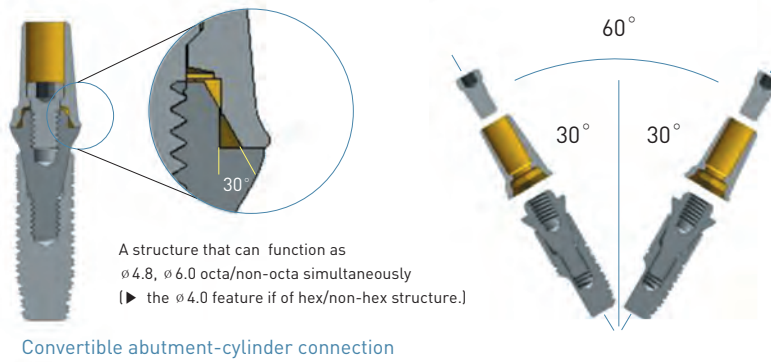

TS & GS Convertible cylinder

- The TS & GS Convertible abutment comes with a temporary cylinder and four types of final prosthesis fabrication cylinders according to the prosthesis type as shown below. A functional prosthesis may be easily fabricated by selecting an appropriate cylinder for usage purposes.

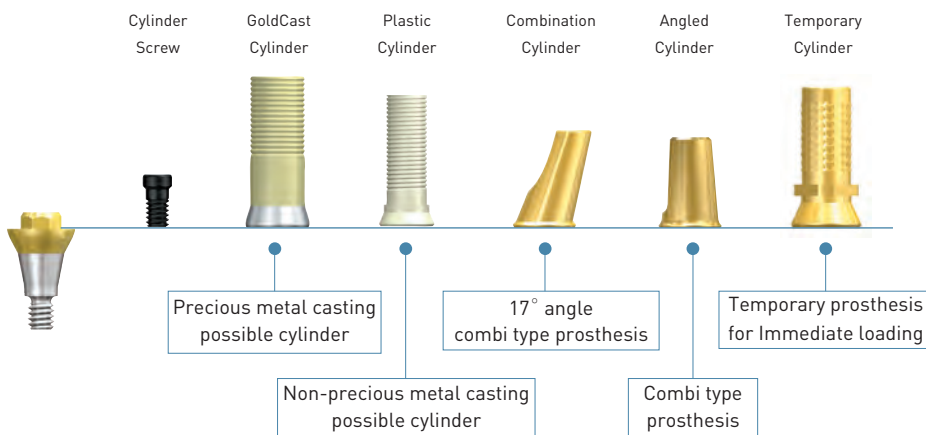

DENTAL CLINIC WORKING

Step1 Healing abutment separation

Components & tools

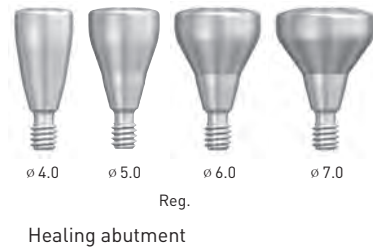
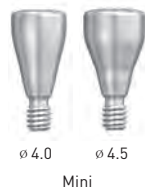
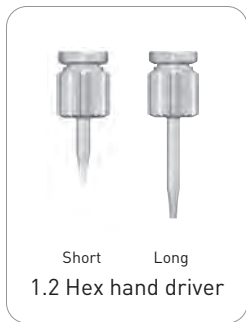

Prosthetic procedure

Separate the Healing abutment using a 1.2 Hex hand driver



Healing abutment verification



Gently separate the Healing abutment manually

Convertible abutment

Combi type restoration

DENTAL CLINIC WORKING

Step2 Abutment selection

Convertible abutments & tools



Prosthetic procedure

Select an appropriate abutment considering the prosthesis and oral environment of the patient. Connect the abutment to the fixture using a carrier and exactly connect with 30 Ncm force with a O-ring driver for $\phi 4.0$ and Octa driver for $\phi 4.8/\phi 6.0$. Always take an x-ray to verify the exactness of the connection.



Step3 Impression

Convertible pick-up impression coping



Prosthetic procedure

Prepare a custom open tray and a Convertible pick-up impression coping of identical diameter with the abutment that has been used. Follow conventional methods but the diameter of the Convertible lab analog must be identical to the abutment.



Impression coping connection



Impression



Lab analog connection

Convertible abutment

Combi type restoration

Step4 Protect cap connection and fabrication of temporary prosthesis

Convertible protect caps & temporary cylinders

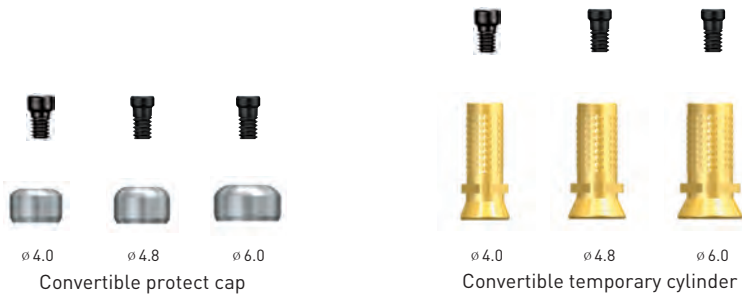

Prosthetic procedure

Connect the protect cap after impression taking before the prosthesis is completed or fabricate a temporary prosthesis using a temporary cylinder.



Protect cap connection



Temporary prosthesis fabrication



Step5 Working model fabrication & cylinder modification

Convertible cylinders



Prosthetic procedure

Make a working model following conventional methods from the impression body and verify the path using a pick-up impression guide pin. Select a cylinder and do milling according to path adjustment need. Be cautious since the selection of an appropriate cylinder lessens milling time and reduction amount.



Path verification using guide pin



Cylinder connection



Cylinder milling

Convertible abutment

Combi type restoration

DENTAL LAB WORKING

Step6 Wax-up ~ prosthesis completion

When milling is finished go through the conventional steps of wax-up to casting and porcelain build-up while maintaining a screw hole. The internal indexing region is short; hence the need to make a transfer jig for use as a guide in intra-oral abutment connection.



Wax-up



Spruing



Casting



Build-up



Completed prosthesis



Fabrication of transfer jig

Step7 Prosthesis setting

Tools

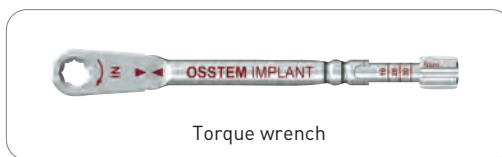
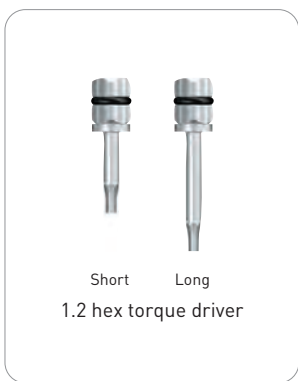

Prosthetic procedure

Connect the abutment intra-orally under the same condition as the model using a transfer jig.
 Connect manually and cement the prosthesis. Loosen the cylinder screw and remove the excessive cement.
 Then finally tighten the cylinder screw with 20 Ncm force and block-out the screw hole.



Cylinder



Cementation



Abutment screw tightening



Hole block-out

Convertible abutment

Combi type restoration

DENTAL CLINIC WORKING

Step1 Healing abutment separation

Components & tools

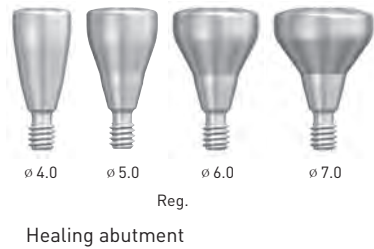
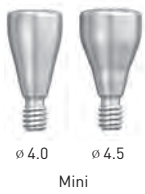

Prosthetic procedure

Remove the Healing abutment using a 1.2 Hex hand driver.



Healing abutment verification



Gently separate the Healing abutment manually.

DENTAL CLINIC WORKING

Screw retained restoration

Step2 Abutment selection and connection

Convertible abutments & tools



Prosthetic procedure

Select an abutment considering the prosthesis and oral environment of the patient. Connect the abutment to the fixture using a carrier. Use a O-ring driver for $\varnothing 4.0$ and Octa driver for $\varnothing 4.8/\varnothing 6.0$ to connect with 30 Ncm torque. Always take an x-ray to check the exactness of the connection.

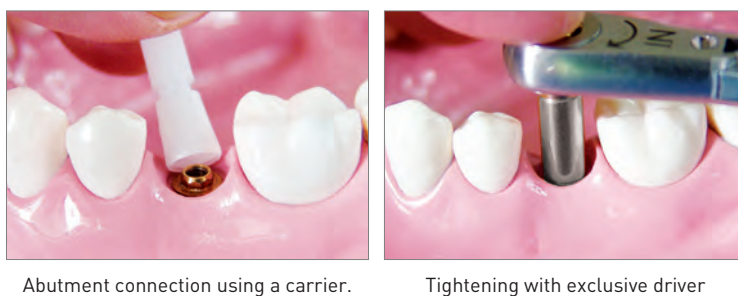

Abutment connection using a carrier.

Tightening with exclusive driver



Screw retained restoration

Step3 Impression

Convertible transfer impression coping



Prosthetic procedure

Prepare a Convertible transfer impression coping of the same diameter as the abutment that has been used. Follow conventional steps but use a Convertible lab analog of the same diameter as the abutment that has been used.

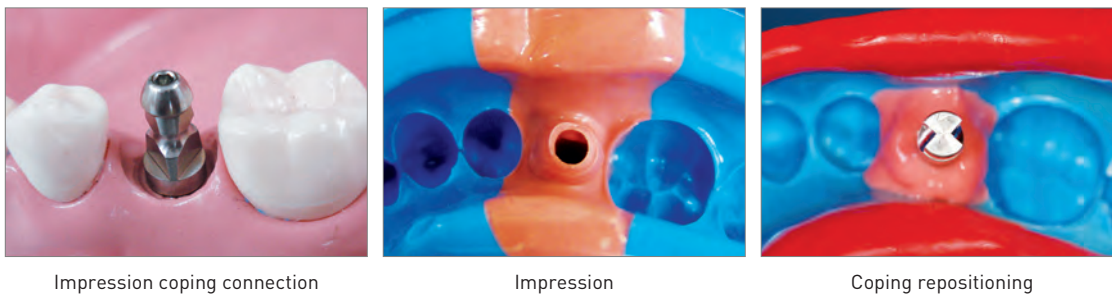

Convertible abutment

Screw retained restoration

Step4 Protect cap connection and temporary prosthesis fabrication

Convertible protect caps & temporary cylinders

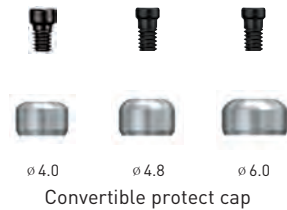

Prosthetic procedure

Connect the protect cap before the prosthesis is finished after impression taking or make a temporary prosthesis using a temporary cylinder.



Protect cap connection

Convertible abutment

Screw retained restoration

Step5 Working model fabrication & cylinder modification

Convertible cylinders

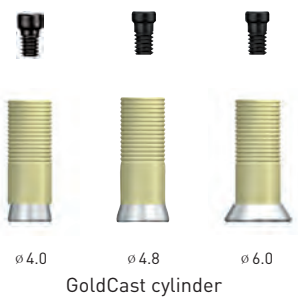
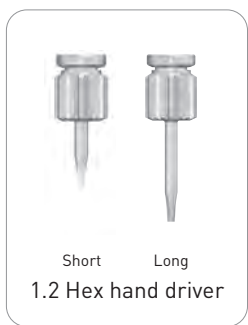

Prosthetic procedure

Fabricate a working model from the impression following the conventional way and connect the abutment. Reduce the plastic area considering prosthesis fabrication space and path. Use a Goldcast cylinder for a prosthesis made of precious alloy and a plastic cylinder for a prosthesis of non-precious allow although the fit is interior.



Working model fabrication



Cylinder connection



Cylinder modification

DENTAL LAB WORKING

Step6 Wax-up ~ prosthesis completion

Do wax-up while maintaining a screw hole on the abutment after finishing height alteration and customizing. It is convenient to use a guide pin from the pick-up impression coping. Cast using a method suitable for precious alloy gold crown/PFG. We prohibit the casting with non-precious alloy since abutment damage may occur.



Wax-up



Casting



Completed prosthesis

Convertible abutment

Screw retained restoration

Step7 Prosthesis setting

Tools

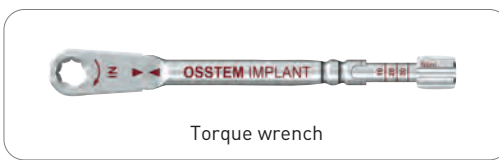
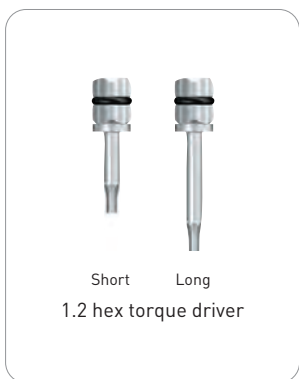

Prosthetic procedure

Check the prosthesis and tighten the final prosthesis with a torque of 20 Ncm. Fill the screw hole on the occlusal surface with cotton. Finally, block-out with resin.



Prosthesis setting

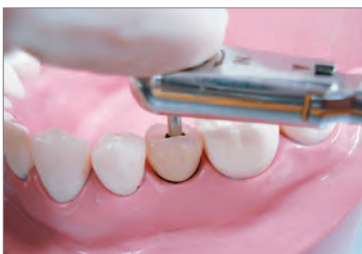

Abutment screw tightening



Hole block-out

DENTAL CLINIC WORKING

Overdenture metal frame fabrication using a Plastic cylinder

The Convertible abutment system is suitable to use for fabrication a bar type overdenture frame. It is possible to make a highly precise gold bar frame using a GoldCast cylinder and an economical bar frame of non-precious metal using a plastic cylinder.



Abutment connection



Impression

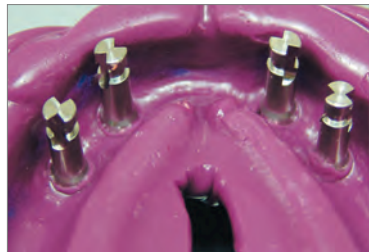

Lab analog connection



Plastic cylinder connection on working model.



Resin frame fabrication



Casting & milling



Completed bar frame

What happens when casting non-precious metal to a Gold abutment/cylinder?

GoldCast abutment and GoldCast cylinder products made of gold alloy are casting abutments exclusive for precious alloy of dental use. Since the melting point of gold abutment and non-precious metal is similar, casting with non-precious metal will cause damage and deformation to the abutment or cylinder during casting, so the use of non-precious metal is prohibited.

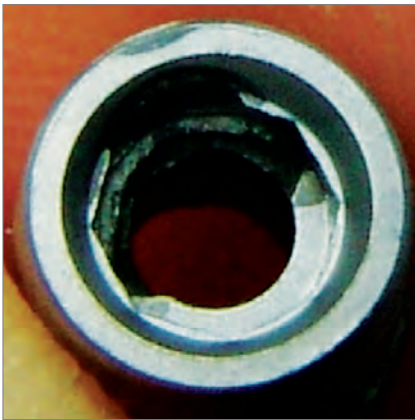

Casted with non-precious alloy metal

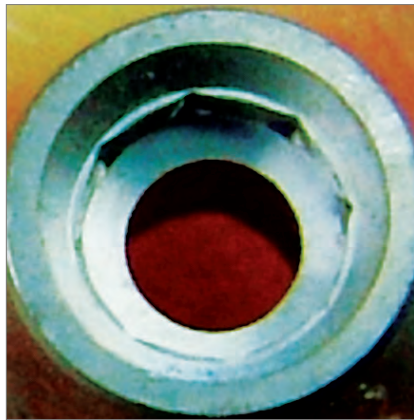

Casted with precious alloy metal

Alloy	Melting range [°C]
GS GoldCast abutment/cylinder	1400~1450
Dental Ni-Cr alloy	1200~1400
Dental Gold alloy	950~1150

TS & GS Stud abutment

- **Indication**

- Stud type overdenture

- **Contraindication**

- Path error over 20° (based on two fixtures)

- **Feature & benefit**

- Fabrication of a functional overdenture with a small number of implant installation.
- O-ring/Dalbo, two types of attachments.
- 4N and 6N retention of O-ring
- Gold coloring considering esthetics

- **Material**

- Abutment : Ti-6Al-4V
- Processing O-ring : Silicone
- Denture O-ring : Silicone
- Dalbo attachment housing : Ti CP-Gr4
- Dalbo attachment lamella : Au-Pt alloy

- **Surface**







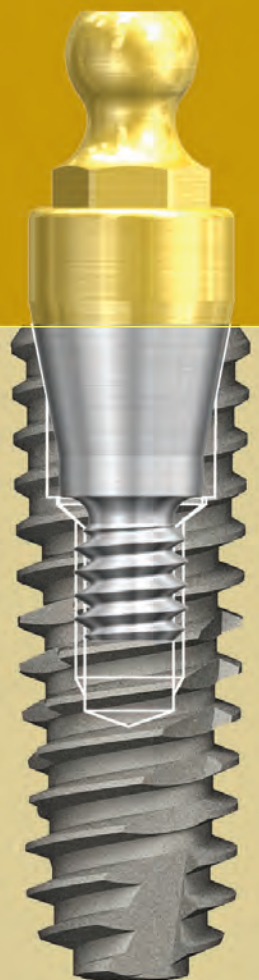

- Abutment : TiN coating

- **Tightening torque**

- Abutment : 30Ncm



Product list for prosthetic procedure

Product list		
Abutment		
Lab analog		
Retainer (cap) + processing O-ring / Duplicate aid	O-Ring	Dalbo
		
Denture O-ring / Dalbo plus attachment		
Retention screw driver		
Abutment driver		
Torque wrench		

- By using the HG Stud abutment it is possible to fabricate a functional implant overdenture with 2 implants. You can use not only the O-ring silicone but also the Dalbo attachment of CM and select and apply the abutment right for the patients condition.

Note for prosthetic process

O-ring system of Stud abutment

- In normal cases, use a retainer cap with good removability. When vertical dimension is limited, the dimension may be decreased by 1.5 mm using a retainer. The initial retention of the yellow-colored O-ring is about 4 N, and that of the orange-colored one about 6N. You can conveniently regain retention when decreased by usage by changing the O-ring. The O-ring system allows path adjustment of up to 20°, although the replacement cycle decreases with increasing deflection; hence the need for caution during path adjustment at the fixture installation step.

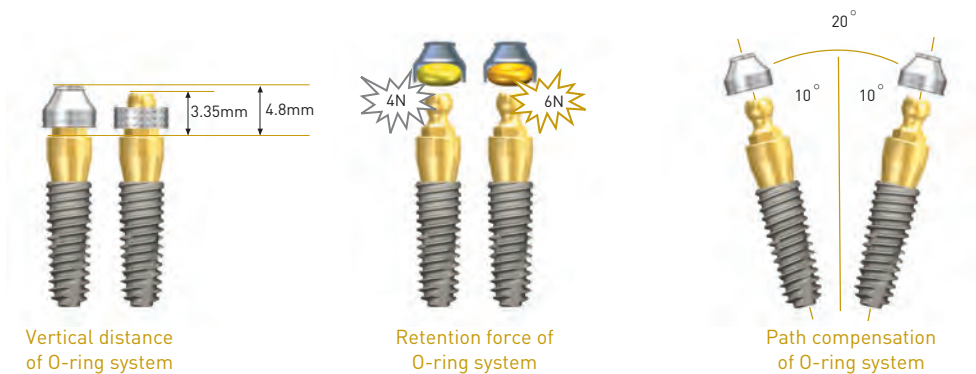

Dalbo system of Stud abutment

- The Dalbo system is maintained by precious metal lamella and the retention can be conveniently adjusted between 2~15 N level using an exclusive driver. The retention can be regained by turning the driver in the clockwise direction. The Dalbo system can compensate a path up to 20° but be cautious since a value larger than this may cause fracture of the lamella.





O-Ring & Dalbo System

DENTAL CLINIC WORKING

Step1 Healing abutment separation

Components & tools



Prosthetic procedure

Remove the Healing abutment using a 1.2 Hex hand driver.
 Since the diameter of the Stud abutment is $\varnothing 3.5$, it is convenient to use the exclusive slim Healing abutment for prosthesis fabrication.



Gently separate the Healing abutment manually.

Step2 Abutment selection and connection

Stud abutments & tools

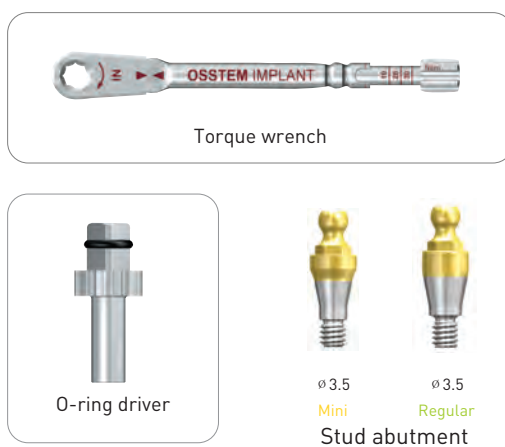

Prosthetic procedure

Select an abutment of appropriate gingival height considering the prosthesis and oral environment of the patient. Connect the abutment to the fixture using an exclusive O-ring driver with 30Ncm force. Always take an x-ray to check the exactness of the connection.



Tightening with exclusive driver

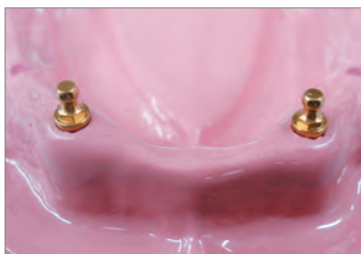

Connected Stud abutment

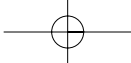

O-Ring & Dalbo System

Step3 Impression ~ working model fabrication

Stud lab analog



Stud lab analog

Prosthetic procedure

Prepare a conventional custom tray for prosthesis impression taking and first inject impression material around the abutment. Take a functional impression same as denture fabrication. after the impression body has set place the lab analog using the replicated hex structure as a guide.

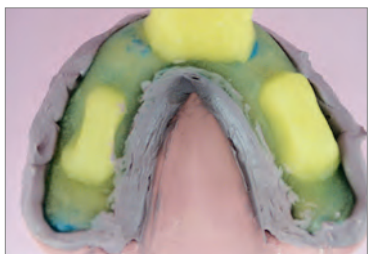

Impression



Lab analog connection



Working model fabrication

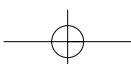



DENTAL LAB WORKING

Step4 Retainer cap /duplicate aid setting ~ curing

Processing components

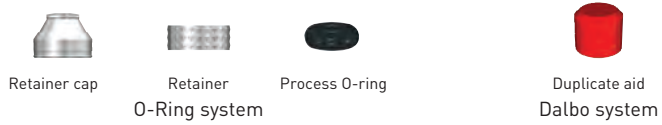

Prosthetic procedure

Connect the retainer cap with an attached processing O-ring to the lab analog exposed on the working model and block-out the lower area. Complete the prosthesis by following the conventional steps for denture fabrication from wax denture to curing. Use the included Duplicate aid when using the Dalbo system.

O-ring



Retainer cap connection

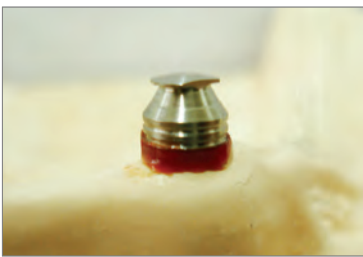

Block-out of lower area

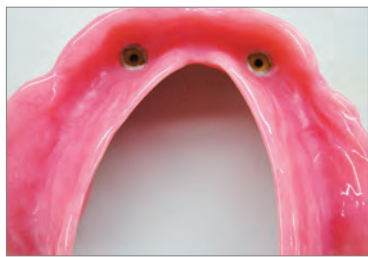

Completed overdenture

Dalbo



Duplicate aid connection

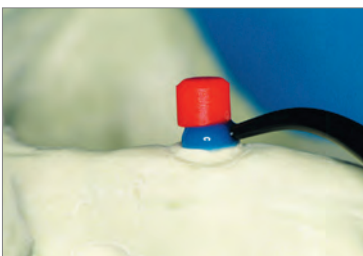

Block-out of lower area



Completed overdenture

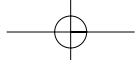

O-Ring & Dalbo System

Step5 Prosthesis setting (O-ring system)

Final O-rings

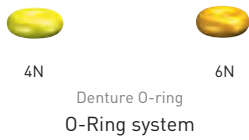

Prosthetic procedure

Remove the processing O-ring of the retainer using tweezers and place the prosthesis after selecting between 4N/6N and connecting the O-ring of appropriate retention.

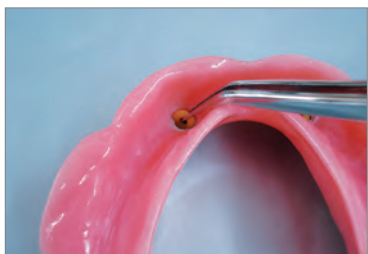

O-ring replacement I

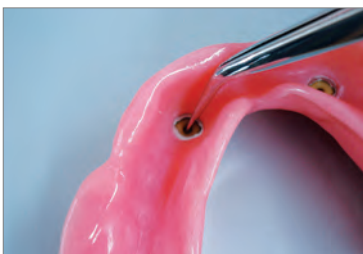

O-ring replacement II



Placed overdenture

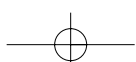

DENTAL CLINIC WORKING

Step5 Prosthesis Setting (Dalbo System)

Dalbo plus attachment & tools



Dalbo plus attachment



Dalbo screw driver

Dalbo system

Prosthetic procedure

Remove Duplicate aid from the completed prosthesis and attach the Dalbo plus attachment intra-orally. Do not forget to block-out the undercut of the lower part to stop the resin inflow. Form a lingual hole on the prosthesis and reposition intra-orally. Then inject resin into the hole to complete. Inject an abundant amount until the resin overflows.

Set the prosthesis with suitable retention by turning the exclusive screw driver in a clockwise manner.



Duplicate aid removal

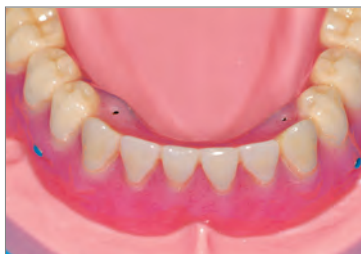

Lingual hole formation

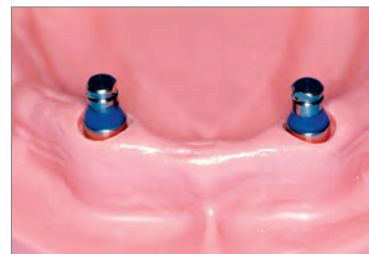

Undercut block-out



Inject resin







Retention adjustment



Placed overdenture

Screw tightening torque guide of TS & GS system

[Unit: Ncm]

Type of product	Mini	Regular	
Cover screw Healing abutment. Impression coping Bite index			Hand tightening (less than 10Ncm)
Rigid abutment Convertible abutment Stud abutment			30 30
Transfer abutment Angled abutment FreeForm ST abutment GoldCast abutment ZioCera / ZioCera Angled abutment			20 30
Convertible cylinder Protect cap			20 20

Torque wrench user guide



Infiniteness wrench

- **When an infinite amount of torque is needed.**

- When a torque over 50 Ncm is necessary in cases such as it is difficult to completely install a fixture with an engine or removal is needed the Torque wrench can be transformed to be used.

- ① Loosen the torque modifying area of the lower part to under 10 Ncm.
- ② Release by pulling at the upper head part and body.
- ③ Complete right angle locking by turning the head 90°

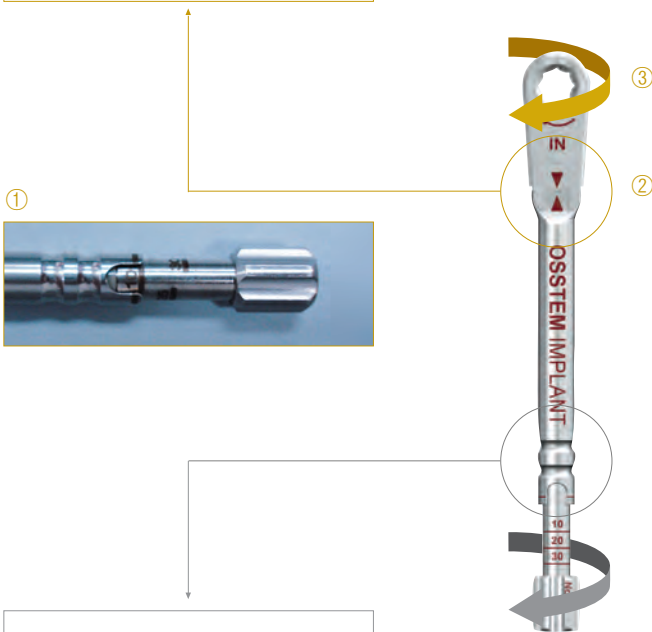

Torque control



30Ncm



20Ncm

- **Tightening torque adjustment**

- The tightening torque value is different depending on prosthesis type and screw. Set at exact torque value by matching the line at the lower part and bend until the neck of the Torque wrench is bent to tighten the prosthesis with the exact torque.

TS & GS Bite index

The Bite index is a product to help to bite taking step after impression taking. It was only possible at abutment and fixture level impression. By using a Bite index, the bite is taken simultaneously with the impression when using abutment with fixture level impression such as Transfer, Angled, Goldcast, etc. Then the number of hospital visits decrease for the patient. An extra bite jig is unnecessary which lessens the procedure steps. The convenience is maximized by allowing adjustment of bite indexing material thickness with five features(4,6,8,10,12).

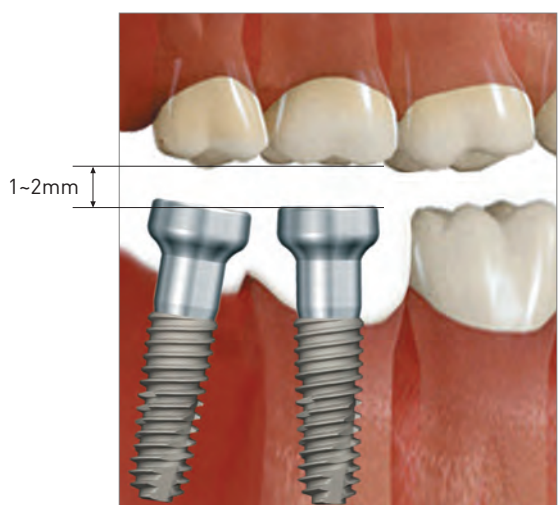
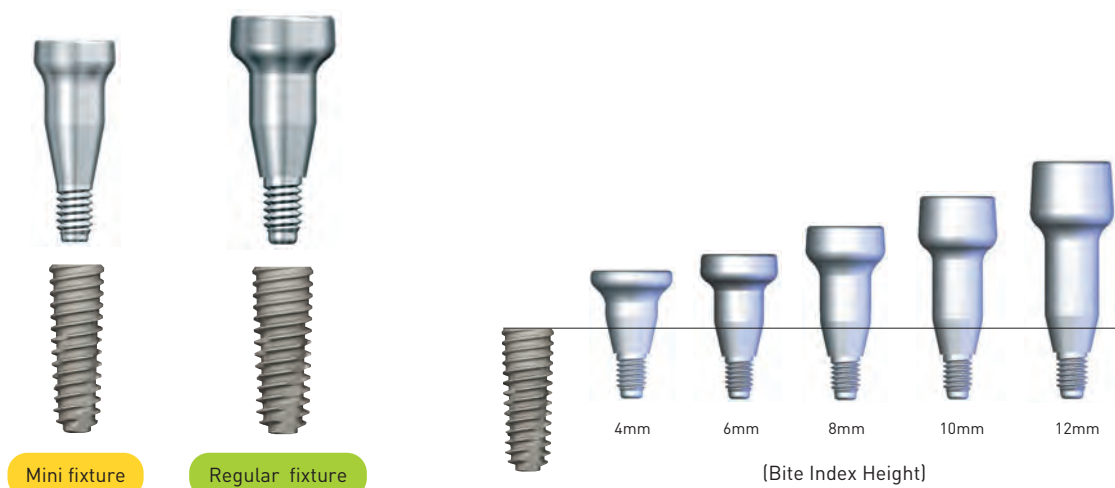

• Bite index characteristics

1. The hospital visits are decreased for the patients by easily and exactly registering the bite right after impression.
2. Extra jig fabrication is unnecessary by using a reusable bite exclusive component.
3. Easy and rapid connection possible free from limitations of the gingival tissue.
4. Applicable to various oral environments of patients with 4, 6, 8, 10, 12 mm features.

Bite indexing procedure

After fixture level impression with pick-up/transfer type, you can register a bite using the Bite index. When a large number of implants have been used or bite indexes of various height have been applied you must provide exact information, such as marking to the lab so it is possible to know the position of the Bite index used intra-orally.

Clinic process

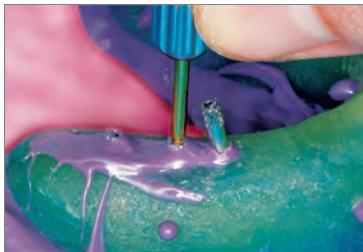

Fixture level impression



Bite index connection



Bite index height verification

Lab process



Bite indexing material injection



Registered bite information



Working model fabrication



Verify exact setting after cutting



Fixation of upper and lower working model



Mounting completed

Benefit of TS & GS Fixture transfer impression coping

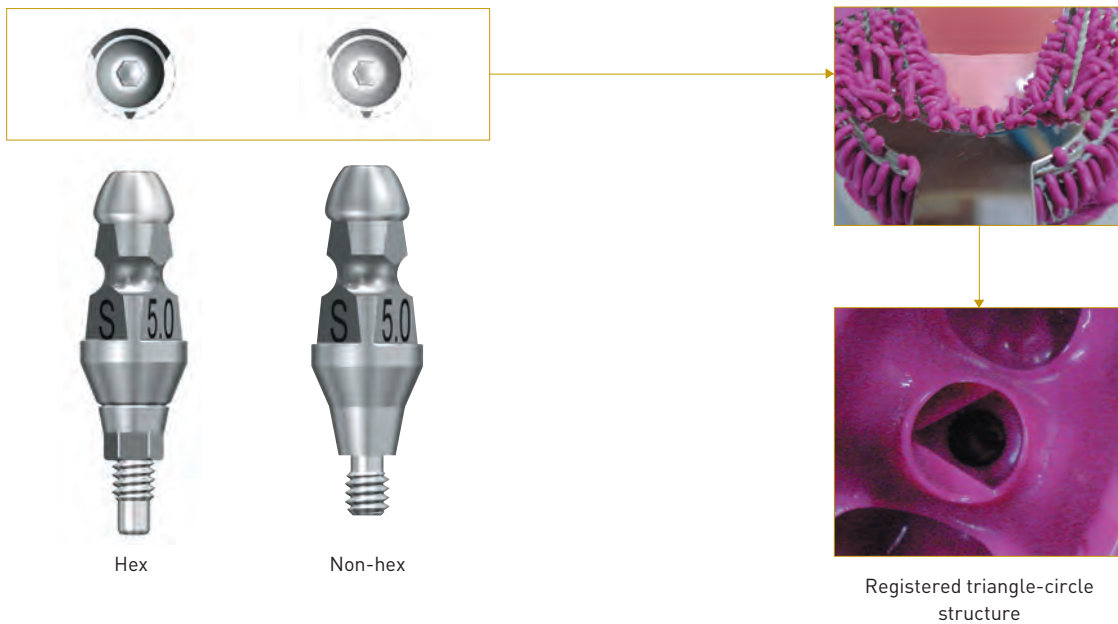

The TS & GS Fixture transfer impression coping allows easy and exact coping repositioning after impression taking by using the triangle-circle structure () for superior direction and position identification. Also the long/short (12.5mm /9.5mm) two features overcome path and intermaxillary interference. The vertical impression error can be prevented by blocking-out the driver hex hole after connecting the coping.

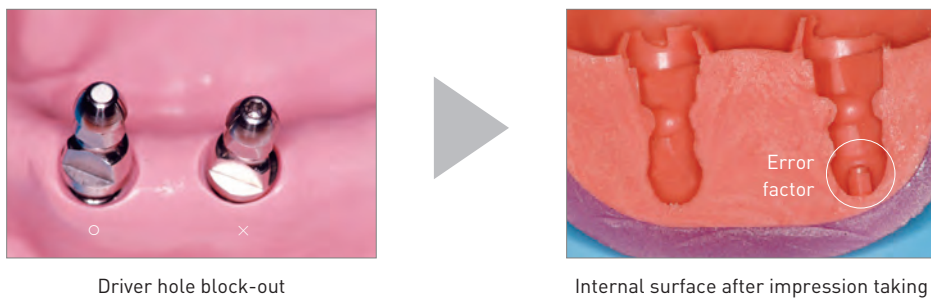

• Error prevention by driver hole block-out



Benefit of TS & GS Fixture pick-up impression coping

You can take an exact impression even when the conventional pattern resin connecting procedure is omitted since the TS & GS Fixture pick-up impression coping has a hole () structure that allows stable impression material fixation in the rotation/vertical direction. We overcame the interference caused by upper part asymmetry () and interference between tray and opposing tooth with long/short feature.

When inevitably placed in the B-L direction, fabricate a tray with coping space that prevents interference between the coping and tray while taking an impression.

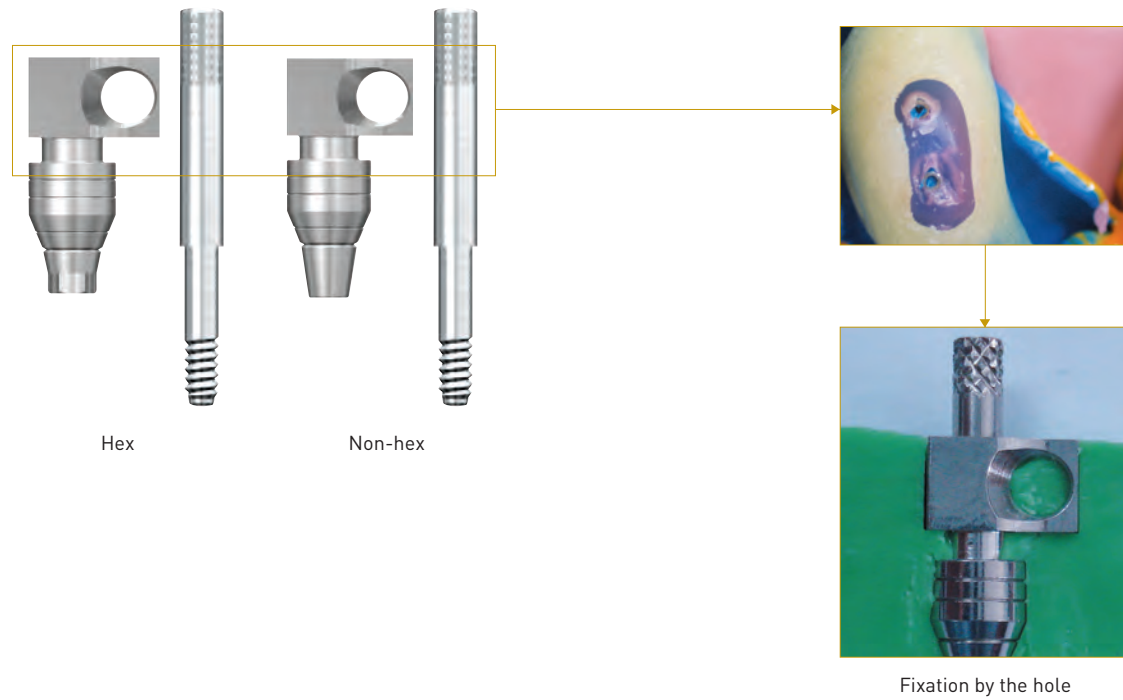

• Pick-up impression coping arrangement



Single



Free end bridge

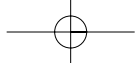

- Verify the exactness of the connection with the upper structure using an x-ray!

With an internal subgingival-type implant such as the GS system, there is a need to verify the connection with the abutment and impression coping by taking an x-ray.

Incomplete connection can directly cause the loosening of the screw and abutment and fracture.

To verify the exact connection, check the 11° taper setting with an x-ray.

Exact connection of the healing abutment



Right connection

Wrong connection

- A wrong connection such as that in the right picture may be caused by interference with bone or adjacent tissue surrounding the installed fixture.

After removing the interference using tools such as a bone profiler, verify the exact connection as in the left picture.

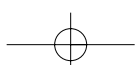

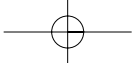

Exact connection of the fixture pick-up impression coping

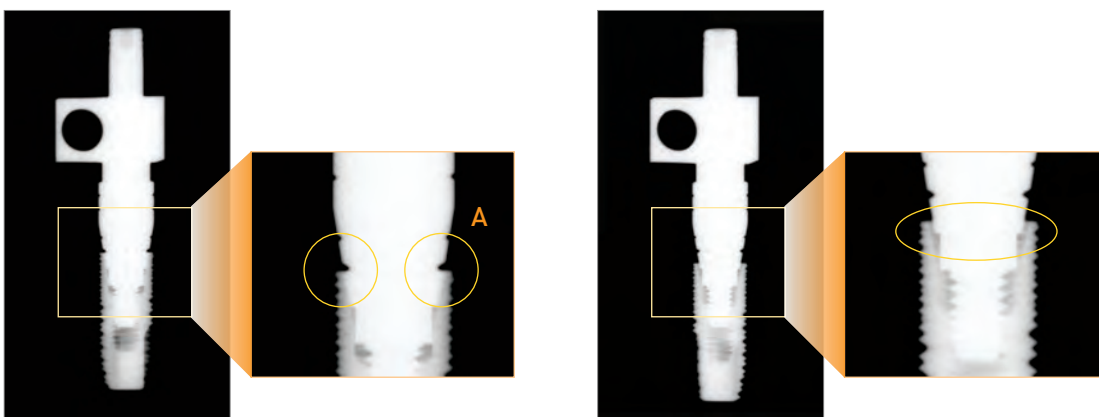

Right connection

Wrong connection

- A wrong connection of the fixture pick-up impression coping such as that in the right picture may be caused by the incorrect setting of the hex with the fixture hex.

The connection can be verified as in the left picture by aligning the notch (A) in the connecting part of the coping body with the upper part of the fixture or removing the gap on the 11° taper area as with the healing abutment.

Exact connection of the fixture transfer impression coping

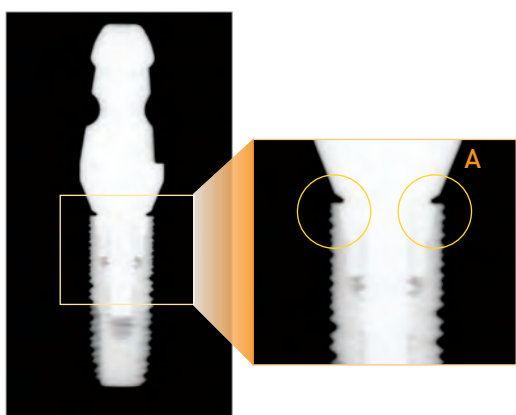

Right connection

- The connection of the fixture transfer impression coping can also be verified by aligning the notch (A) in the connecting part of the coping body with the upper part of the fixture or removing the gap at the 11° taper area.

With this product, connecting the guide pin is structurally impossible when the hex part is incompletely set; thus minimizing user error.

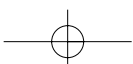

Exact connection of the abutment

• Rigid abutment

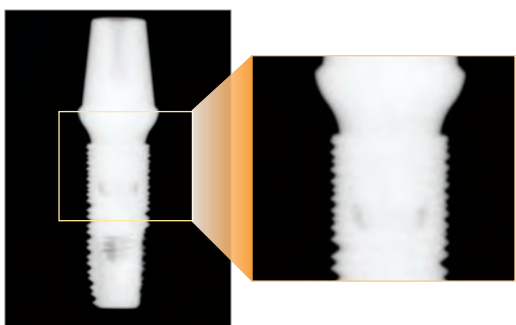

Right connection

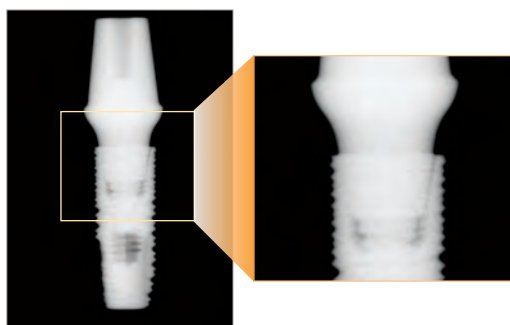

Wrong connection

- A wrong connection of the rigid abutment such as that in the right picture may be caused by interference with bone or adjacent tissue surrounding the installed fixture.

After removing the interference using tools such as a bone profiler, verify the exact connection as in the left picture. Including the rigid abutment, verify the exact connection using an x-ray prior to prosthesis setting with convertible and stud abutments

• Transfer Abutment

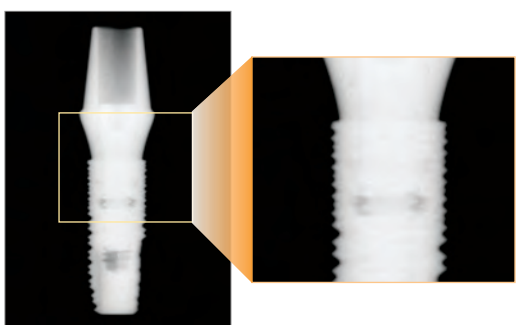

Right connection

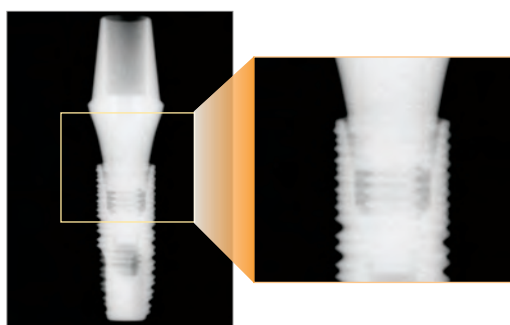

Wrong connection

- A wrong connection of the transfer abutment such as that in the right picture may be caused by the incorrect setting of the hex with the fixture hex or interference with bone or adjacent tissue surrounding the installed fixture.

The former can be corrected by fixing the hex part setting and checking with an x-ray, and the latter, by removing the interference using tools such as a bone profiler and verifying the exact connection as in the left picture. Including the transfer abutment, verify the exact connection using an x-ray before prosthesis setting with angled, Goldcast, FreeForm ST, and ZioCera abutments.

Compatibillity Guide for TS & GS System (Fixture-Abutment)

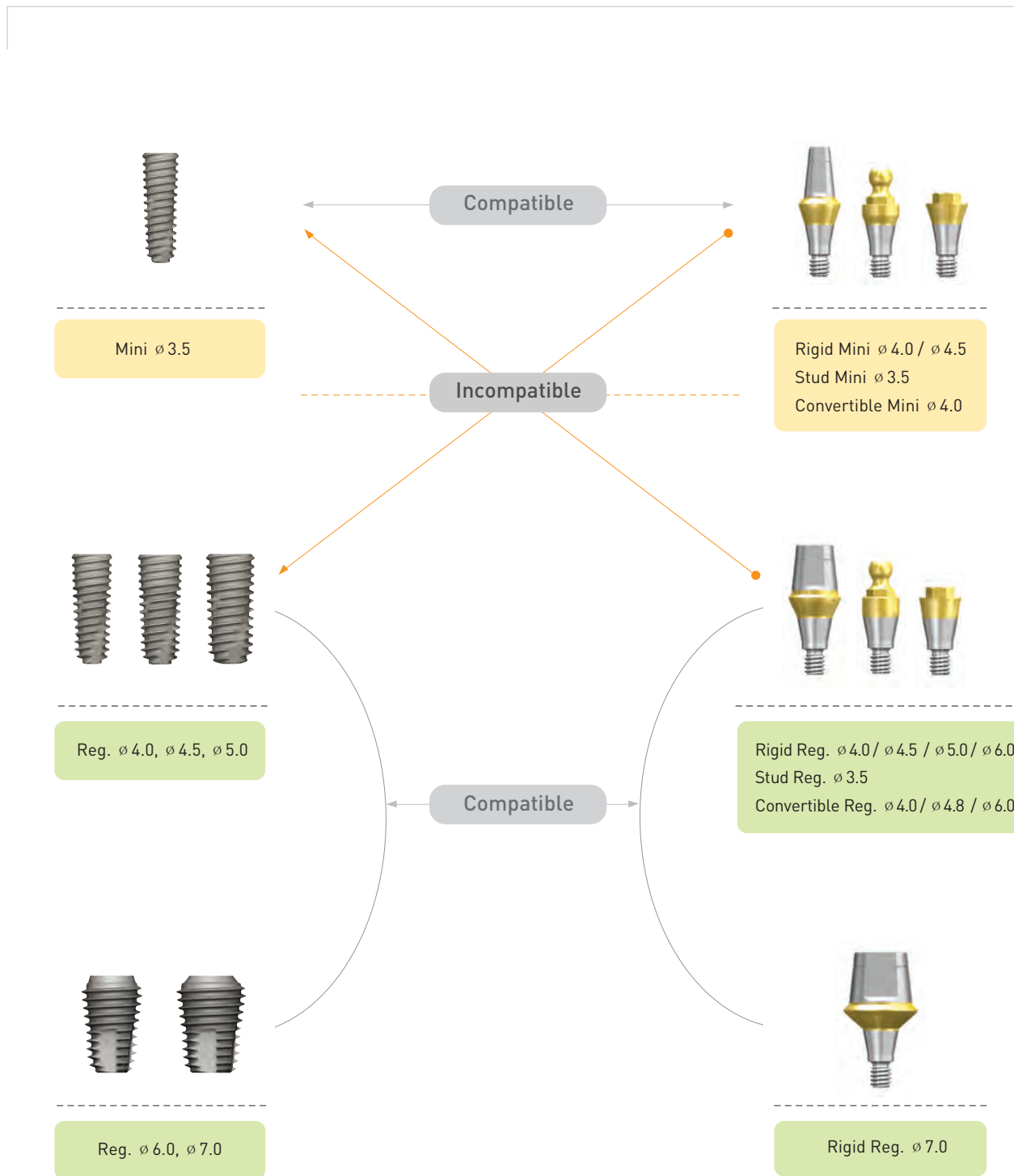

OSSTEM[®]
IMPLANT

